



# KiloVault® 2100 PLC 2100WH 12V Advanced AGM Battery



## Installation and User Manual

## **\*WARNING High Voltage Risk of Personal Injury or Death\*\***

As is the case with all batteries, the risk of shock is present. When handling batteries, use protective measures including, but not limited to, safety glasses, insulated gloves, and protective footwear.

When working with or installing batteries, use electrically insulated gloves and tools. Remove personal metal items such as watches, rings, bracelets, etc.

The information included in this manual is accurate at the time of publication. However, this manual is subject to change without prior notice as we continuously improve our products.

Additionally, the illustrations in this manual are for demonstration only and are intended to help explain the KiloVault® 2100 PLC system concepts and installation instructions. Details may vary slightly depending upon the market region and the product version.

Please note: If this unit is installed by someone other than the end-user, the installer must explain the contents of this installation and user's manual to the end-user.



## Contents

1.	Safety Information .....	4
1.1.	Symbols Used in this Manual .....	4
1.2.	General Safety Precautions and Instructions .....	4
1.3.	Battery Handling Guide.....	6
1.3.1.	Transportation.....	6
1.3.2.	Storage.....	6
1.3.3.	Response to Emergency Situations.....	6
1.3.4.	Qualified Personnel.....	6
2.	Overview.....	8
2.1.	Features .....	8
2.2.	Product Technology.....	8
3.	Specifications.....	9
4.	Operation.....	12
4.1.	Charging.....	12
4.1.1.	Charging Characteristics .....	12
4.1.2.	Temperature Compensation.....	13
4.2.	Discharging .....	13
4.2.1.	Discharge Characteristics.....	13
4.2.2.	Discharge Temperature Characteristics .....	14
4.2.3.	Self-Discharge.....	14
4.2.4.	Recharging.....	15
4.2.5.	Open-Circuit Voltage (OCV) vs. State of Charge (SoC) .....	15
4.3.	Cycle Life .....	16
5.	Environmental Protection .....	17
5.1.	Toxic and Poison Checklist .....	17
5.2.	Recycling .....	17
6.	Technical Support.....	18
6.1.	Downloads .....	18
6.2.	Documentation.....	18
6.3.	Contact Us.....	18







## 1. Safety Information

### 1.1. Symbols Used in this Manual

It is essential to read, understand, and follow these instructions prior to installing or operating KiloVault® batteries.

	<b>Warning:</b> This is a hazardous situation which, if not avoided, could result in serious injury or death.
	<b>Warning:</b> Do not place or install near flammable or explosive materials.
	<b>Warning:</b> Install the KiloVault® 2100 PLC out of the reach of children and animals.
	<b>Warning:</b> The KiloVault® 2100 PLC is heavy, over 127 lb (58 kg), and may cause serious back injury. Lift with multiple people and lifting equipment rated to lift and support at least 140 lb.
	<b>Warning:</b> Do not dispose of this product with household waste.
	<b>Caution:</b> Risk of electric shock.
	<b>Attention:</b> Disconnect the battery before carrying out maintenance or repair.
	<b>Attention:</b> Read this instruction manual <u>before</u> installing and operating the battery.
	<b>Note:</b> Indicates points of particular emphasis that make operation more efficient or convenient.
	<b>Recyclable:</b> Please contact KiloVault® for recycling instructions.

### 1.2. General Safety Precautions and Instructions

	<b>Warning:</b> Failure to follow the instructions in this manual may result in serious injury or death.
	<b>Caution:</b> Risk of electric shock.
	<b>Warning:</b> Do not place or install near flammable or explosive materials.
	<b>Warning:</b> Install the KiloVault® 2100 PLC out of the reach of children and animals.
	<b>Warning:</b> The KiloVault® 2100 PLC is heavy, over 127 lb (58 kg), and may cause serious back injury. Lift with multiple people and lifting equipment rated to lift and support at least 140 lb.
	<b>Warning:</b> Do not dispose of this product with household waste.
	<b>Attention:</b> Read this instruction manual <u>before</u> installing and operating the battery.

- Do not attempt to use any battery that appears damaged during shipment or otherwise.
- Do not submerge the KiloVault® 2100 PLC. This could cause injury and will void your warranty.
- Do not attempt to disassemble the KiloVault® 2100 PLC. Its components are not user serviceable. This could cause personal injury and will void your warranty.
- To avoid the risk of shock or fire, ensure all wire is properly sized and in good condition.
- Do not impact, pull, drag, or step on the KiloVault® 2100 PLC.
- Verify all equipment be connected to the KiloVault® 2100 PLC is off before making connections.
- A small risk of spark does exist while making connections. Ensure the area is free of explosive gasses and liquids and is not installed in confined areas. This includes flammable fuel powered machinery, holding tanks, pipe fittings, and connectors.
- Respiratory irritation may be caused if the KiloVault® 2100 PLC is punctured or cracked.
- Skin contact with a punctured or otherwise open battery can cause irritation.
- If the KiloVault® 2100 PLC becomes punctured or cracked, use appropriate respiratory and hand protection.
- High voltage battery connections (configurations of greater than **36V** DC nominal) can be dangerous in any DC system. The KiloVault® 2100 PLC is a **48V** nominal battery system and is **greater** than 36V DC at the terminals when fully charged! DC voltages over 52V can stop the human adult heart; please be careful and wear insulated gloves.

## 1.3. Battery Handling Guide

In addition to the General Safety Precautions and Instructions, the following guidelines should be observed when handling the KiloVault® 2100 PLC.

### 1.3.1. Transportation

- Because the KiloVault® 2100 PLC weighs over 127 lb, it should be moved with the help of multiple people and moving/lifting equipment rated over 140 lb.
- Do not drop the KiloVault® 2100 PLC.
- If you are transporting KiloVault® 2100 PLC batteries while they are still in the packing crate, do not stack them more than 5 layers high.
- Only transport the KiloVault® 2100 PLC face up.
- Check immediately after transporting.
- If the KiloVault® 2100 PLC is damaged in any way, do not use it; contact KiloVault immediately.

### 1.3.2. Storage

In addition to the General Safety Precautions and Instructions, the following guidelines should be observed when storing the KiloVault® 2100 PLC.

- Store in a clean, dry, shaded, and well ventilated area, at a temperature between 15 °C and 35 °C.
- Charge to at least 70% (the state of charge upon delivery) before storage.
- Store no longer than 6 months.
- Repeated (100%) discharges will decrease battery capacity.
- Fully charge the battery within 15 days of a deep discharge of 90% or more.
- Do not drop, stack, or turn upside down.
- Store away from children and animals.

Keep your batteries away from heaters and organic solvents. An increased storage temperature results in an increased self-discharge rate, so store them in a cool dry environment.

### 1.3.3. Response to Emergency Situations

The KiloVault® 2100 PLC is designed to prevent hazards resulting from failures; however, no battery system is 100% safe, and KiloVault, LLC cannot guarantee its absolute safety.

In the unlikely event of a fire, if possible, first shut off the source of the electricity. We recommend having a fire extinguisher in close proximity of your power generating equipment. Class ABC extinguishers are easily obtainable and are best suited for multipurpose fire types such as wood, flammable liquids, and electrical appliances.

### 1.3.4. Qualified Personnel

This guide, and the tasks and procedures described in this manual, are intended for use by qualified personnel only. Only qualified personnel shall install, operate, overhaul, or maintain the KiloVault® 2100 PLC. During maintenance or overhaul, at least two people (equipped with protective measures, including but not limited to, safety glasses, insulated gloves, and safety shoes) must be present.

Qualified personnel are defined as being a trained and locally certified electrician or installer who has of the following knowledge, skills, and experience:

- Functional principles and operation of on-grid and off-grid (backup) electrical systems
- Dangers and risks associated with installing and using electrical devices and acceptable mitigation methods
- Installation of electrical devices
- Knowledge of and adherence to the information in this guide, to all applicable safety precautions, and to electrical industry best practices

When working with any battery system, ensure you have the necessary tools and safety equipment, including but not limited to:

- Insulated tools
- Rubber apron and gloves
- Face protection/face shield
- Safety goggles
- Fire extinguisher
- Emergency eyewash and shower, if available
- Acid spill cleanup kit

Use the following safety precautions:

- Pay attention to electrical warning symbols to avoid serious injury or death caused by electrical shock or burns.
- Remove all rings and jewelry while working on batteries.
- Multi-cell battery systems can attain high voltage and/or currents. Do NOT touch uninsulated batteries, connectors, or terminals. To prevent serious electrical burns and shock, use EXTREME CAUTION when working with DC Battery system.
- Always wear protective clothing.
- Protect your eyes and any exposed skin.
- Use non-conductive or insulated tools when working with ANY battery system.
- All installation tools should be adequately covered with vinyl electrical tape or suitable non-conductive material to minimize the possibility of shorting across connections.
- Never lay tools or other conductive objects on the battery.
- Do not short circuit these batteries.
- Do NOT throw away these batteries, they are recyclable.

## 2. Overview

### 2.1. Features

- Maintenance Free: No watering, 2-year shelf life, and low self-discharge rate
- Maximized Cycle Life: Affordable high performance with 3000 Cycles at 50% depth of discharge (DoD)
- Super-Fast Charging: High charge rates allow the KiloVault® 2100 PLC to go from 50% up to 90% state of charge in under an hour
- Exceptional Value: Less cost per kWh cycle than other lead acid batteries
- Advanced Technology: KiloVault® 2100 PLC high power, energy dense batteries have a specially formulated carbon additive that enhances the overall battery life
- Partial State of Charge (PSoC) Applications: Pure lead + carbon = greater cycle life in both PSoC and non-PSoC off-grid operations
- 5 Year Limited Warranty

Our newest member of the KiloVault family is not a sibling but a cousin! The 2100 KiloVault® 2100 PLC is a pure lead carbon sealed AGM deep cycle solar battery. It is a cost-effective, maintenance-free battery offering superior performance in PSoC applications. These batteries are designed for residential or light commercial off-grid, backup, or self-consumption applications.

The KiloVault 2100 PLC is a Premium Pure Lead Punched Grid Cycling Battery, with excellent anti-corrosion performance, and low float current, greatly extending calendar and cyclic life.

The KiloVault 2100 PLC has advanced Pure Lead + Carbon, which offers superior performance in PSoC applications. Other lead acid chemistry batteries sulfate and lose overall performance when left in a low state of charge over time. Solar energy storage could be discharged, followed by an extended period of cloudy days, reducing the charging performance of the solar panel, and therefore not charging the energy storage battery for days. With the KiloVault 2100 PLC, this is not a problem.

It doesn't stop there. The KiloVault 2100 PLC has strong high temperature ABS/Polycarbonate Flame Retardant jars to UL94V-0 and <28% LOI (limiting Oxygen Index). Plate design provides consistent, low internal resistance, and larger reaction surface. The large top posts allow low connector resistance, and the convenient Front Terminal Adapter allows fast and easy installation, zero overhead space required, and easier maintenance records documentation.

### 2.2. Product Technology

- Valve Regulated Lead Acid (VRLA) maintenance free
- Pure lead punched grid plate with low self-discharge
- Excellent Charging Acceptance with High Charging Efficiency
- UL94V-0 ABS+PC enclosure
- Excellent PSoC Cycle Performance
- Super-Fast Charging: from 50% up to 90% state of charge in under an hour
- Integrated valve design controlling water loss, acid fog, and improved explosion resistance



### 3. Specifications

Specifications	KiloVault® 2100 PLC
Rated Energy Capacity Watt Hours (Wh)	2160 Wh
Rated Voltage	12V
Nominal Amp-Hour Capacity (C20 Hr Discharge)	180 Ah
Float Charging Voltage	13.7V
Bulk/Absorption Voltage	14.1 to 14.4V
Equalize Voltage	14.1V
Maximum Equalize time	24 Hours
Battery Efficiency	87%
Recharge / Re-bulk Voltage for 50% DoD	14.4V at 77°F (25°C)
Charge End Amps	0.32A
Max Discharge Current	500A (5s)
Max Charge Current	140A (100A recommended)
Max Configuration	Up to 4, 48V strings in parallel
Nominal Operating Temperature Range	77° +/- 5°F (25° +/- 3°C)
Operating Temperature Range	Discharging: -40 to 131°F (-40 to 55°C) Charging: -4 to 113°F (-20 to 45°C) Storage: -4 to 122°F (-20 to 50°C)
Cycle Life	3000 (50% DoD)
Self-Discharge Rate	Batteries can be stored up to 24 months at 77°F (25°C). For higher temps, the time interval will be shorter. Battery should be given a top off charge when the open circuit voltage approaches 12.6V, or when the max storage time is reached, whichever occurs first.
Terminals	Top Terminal M8 Insert Front Terminal M6 Adapter
Top Terminal Torque	97.36 to 106.21 in lb (11 to 12 N m)
Front Terminal Torque	62.84 to 70.80 in lb (7.1 to 8 N m)
Battery Interconnects / Terminal Covers	Included

Dimensions (L x W x H)	22 in x 4.92 in x 12.6 in
Weight	127 lbs.
Warranty	5 Year

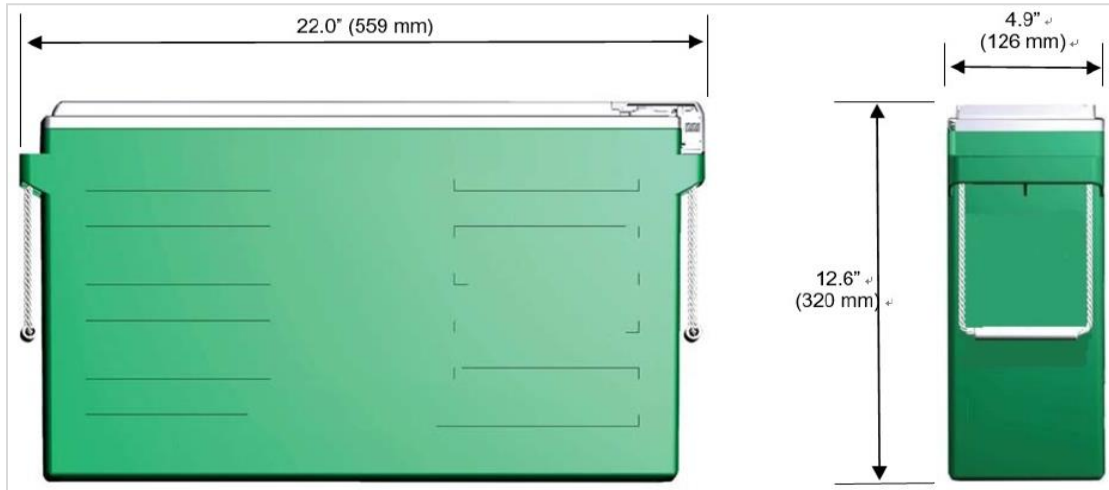

Figure 1: Physical Dimensions

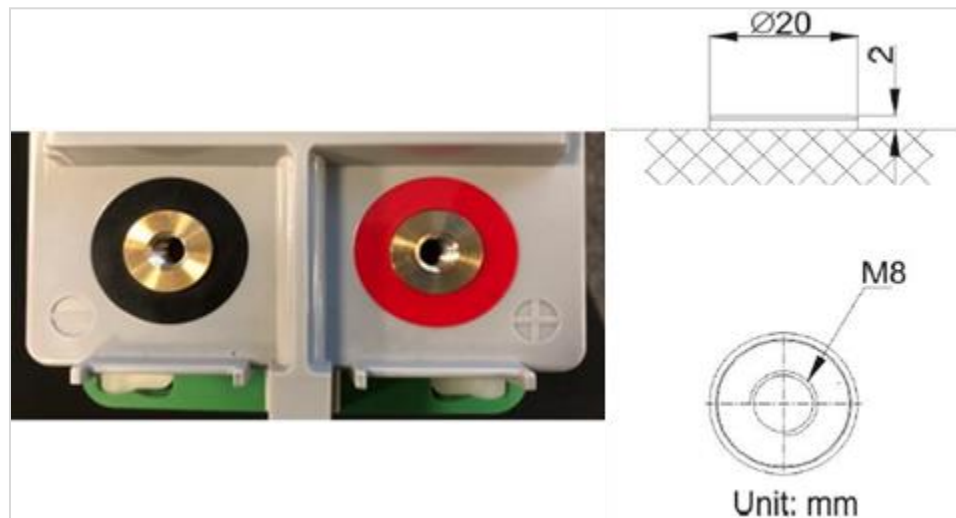

Figure 2: Battery Terminals

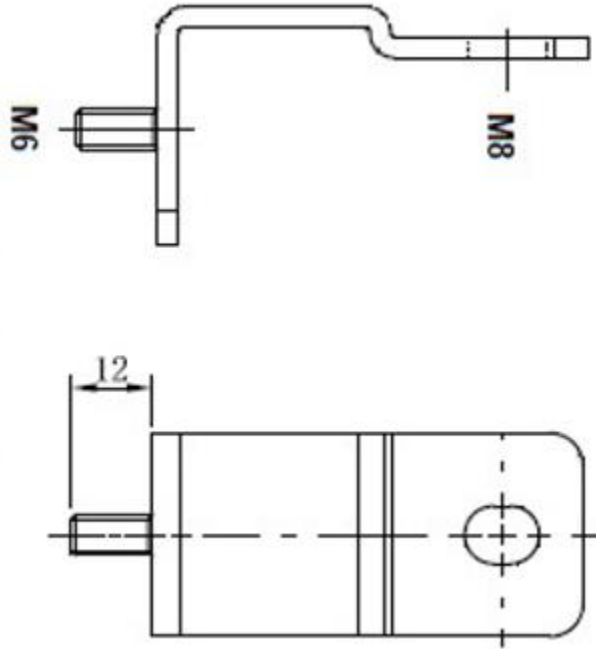

Figure 3: Terminal Interconnects

## 4. Operation



### 4.1. Charging

KiloVault 2100 PLC batteries are usually charged using a three-stage charging cycle: bulk, absorption, and float stages. Bulk is a constant-current stage. The purpose of the bulk stage is to raise the battery voltage to a relatively high level with an initial fast charge. Absorption is a constant voltage stage. It is established upon reaching the absorb voltage settings. The battery is considered to be full when the following conditions are met: The charge current must taper down to a level between 1% and 2% of the total battery amp-hours while maintaining the absorption voltage. The charger can then exit absorption and then enter the float stage. The float stage is a maintenance stage which ensures the battery remains fully charged.

#### 4.1.1. Charging Characteristics

Not all chargers are designed or programmed the same way. Please use the following settings for chargers, inverter/chargers, and charge controllers.

- Bulk / Absorption: 14.1VDC
- Equalize: 14.1VDC
- Float: 13.62VDC

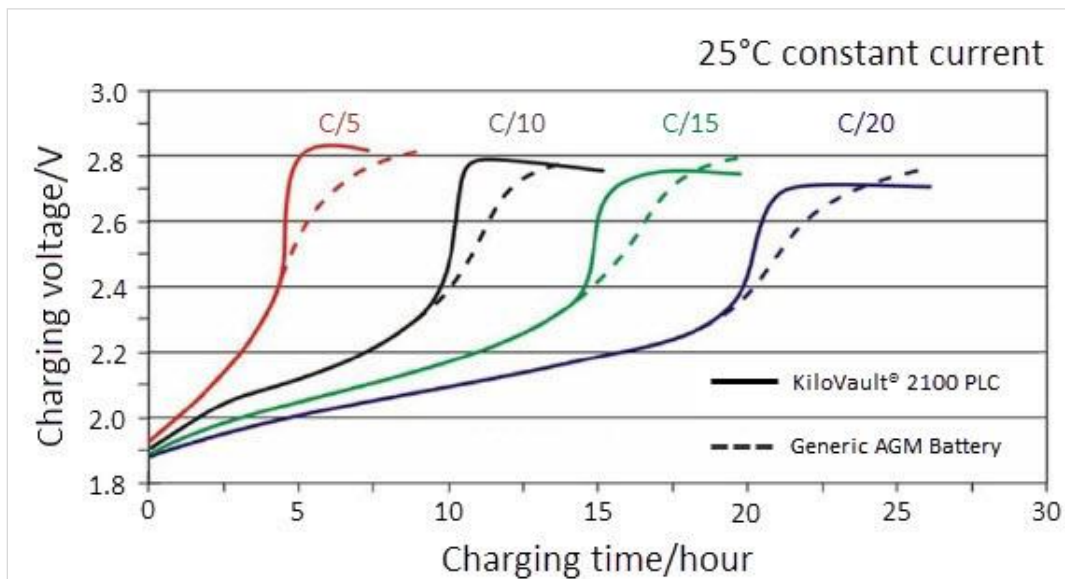

Figure 4: Constant Current Charge

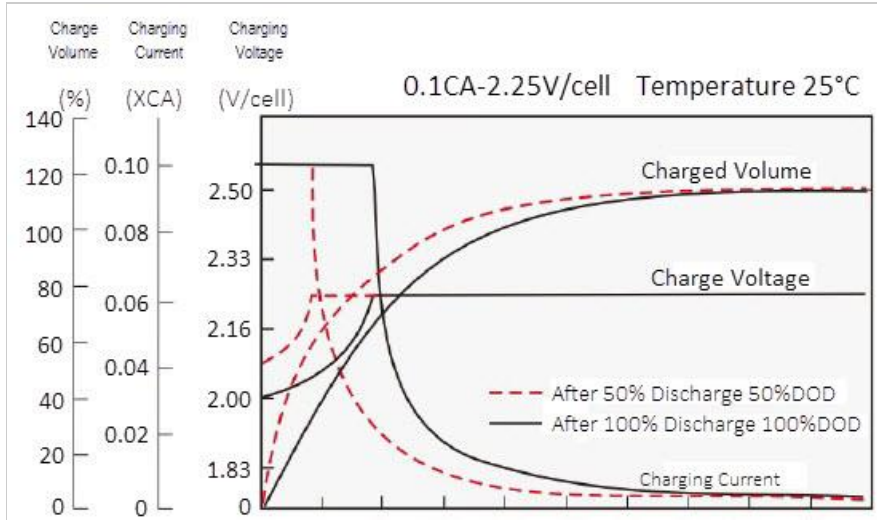

Figure 5: Constant Voltage Charge

#### 4.1.2. Temperature Compensation

To achieve longer battery life, compensate for temperatures above or below 77°F (25°C). For KiloVault 2100 PLC batteries we recommend -30mV/°C (-5mV/cell/°C).

## 4.2. Discharging

Battery capacity depends on the discharge current or discharge rate. If the discharge current is smaller, the discharge capacity will be larger. If the discharge current is larger, the discharge capacity will be smaller.

#### 4.2.1. Discharge Characteristics

The final voltage is based on the discharge current and the minimum allowed by the system setup.

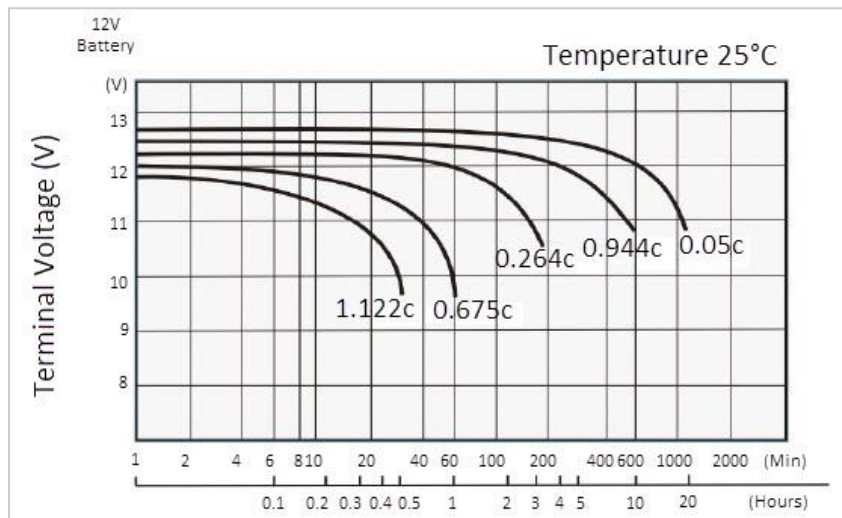

Figure 6: Discharge Curves Given Different Discharge Currents

## 4.2.2. Discharge Temperature Characteristics

Battery capacity increases with the temperature. The size of the effect the temperature has is affected by the discharge current/discharge rate. This effect becomes more obvious when the battery is discharged at a larger current.

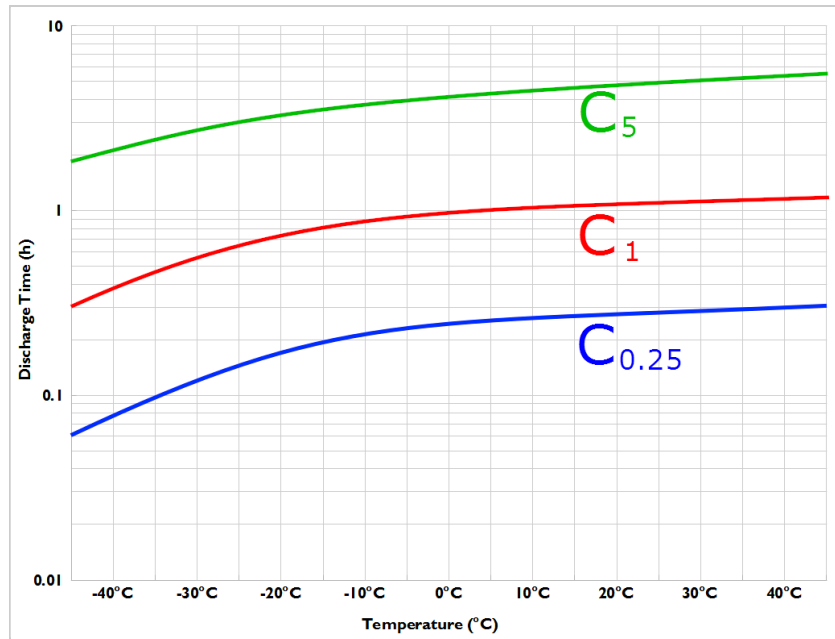

Figure 7: Temperature Effects on Capacity Discharge Rates

## 4.2.3. Self-Discharge

Stored batteries will need to be recharged to recover from self-discharge. The rate of self-discharge increases as the temperature increases.

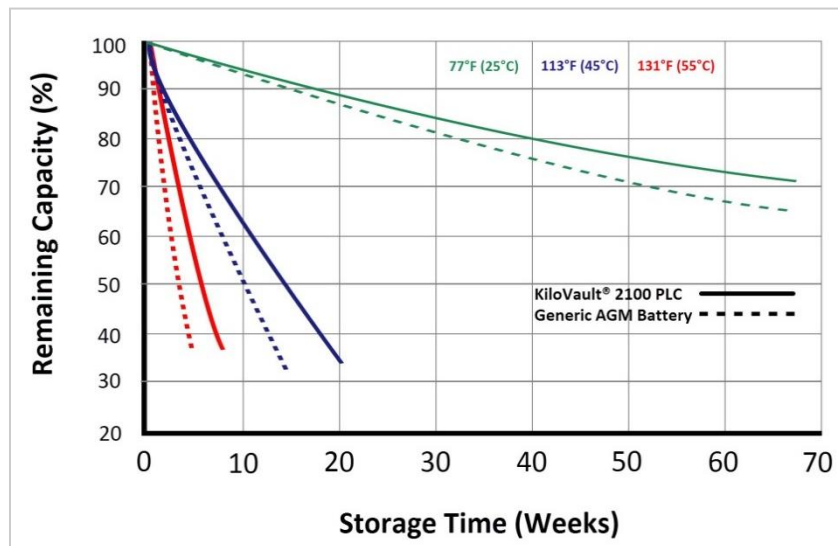

Figure 8: Self-Discharge Curves

#### 4.2.4. Recharging

Generally speaking, lead sulfate will be produced on the battery negative plate when they are stored for a long time. KiloVault® 2100 PLC batteries can be stored for up to 24 months. Because lead sulfate is an electrical insulator, it negatively affects the performance of the battery. We recommend the following recharge schedule based on storage temperatures.

If a battery is stored under 68°F (20°C), it should be recharged every 9 months, at a constant 13.38V to 13.62V, current limit 0.25C<sub>10</sub> for 2 to 3 days.

If it is stored between 68°F and 86°F (20°C to 30°C), it should be recharged every 6 months at 13.8V to 14.4V, current limit 0.25C<sub>10</sub> for 10 to 16 hours.

If it is stored between 86°F and 104°F (30°C to 40°C), it should be recharged every 3 months at 13.8V to 14.4V (temperature compensated -3mV/°C), current limit 0.1C<sub>10</sub> for 8 hours or 0.05 C<sub>10</sub> for 16 hours.

#### 4.2.5. Open-Circuit Voltage (OCV) vs. State of Charge (SoC)

The open-circuit voltage of lead acid batteries varies with the specific gravity of the electrolyte. While discharging, the specific gravity of the electrolyte changes greatly but cannot be measured in a closed battery, so the open-circuit voltage is measured and the approximate residual capacity is calculated.

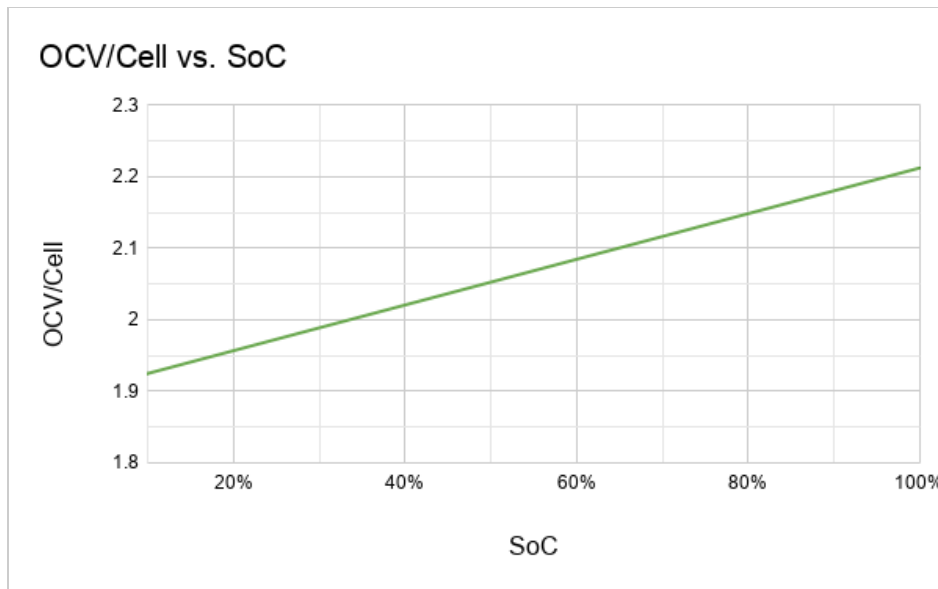

Figure 9: OCV/Cell vs. SoC

## 4.3. Cycle Life

The cycle service life of the battery is related to the frequency of discharge, the depth of discharge, the floating voltage, and the working environment. Total cycle life decreases with increasing temperatures and depths of discharge.

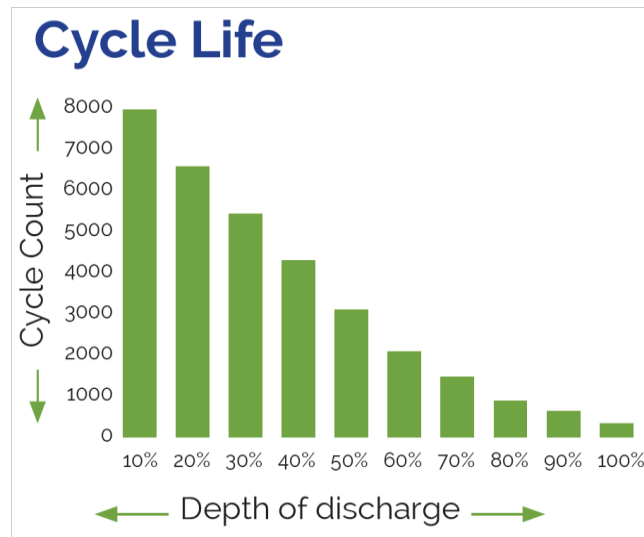

Figure 10: Approximate Total Cycle Count vs. DoD



## 5. Environmental Protection

### 5.1. Toxic and Poison Checklist

Battery Component	Presence of Toxic or Poisonous Substances						
	Cu	Pb	Hg	Cd	Cr(IV)	PBB	PBDE
Terminal	Present	Not Present	Not Present	Not Present	Not Present	Not Present	Not Present
Container	Not Present	Not Present	Not Present	Not Present	Not Present	Not Present	Not Present
Inner Materials	Not Present	Present	Not Present	Not Present	Not Present	Not Present	Not Present

### 5.2. Recycling



This battery cannot be disposed of with other waste. In order to prevent the release of potentially hazardous substances, risks to the environment, and risks to human health from improper hazardous waste disposal, do not throw away this battery in the general waste stream. Please recycle it.

In order to recycle this battery, please use your local recycling system or contact your waste management authority for the proper lead-acid battery recycling procedures in your area.

## 6. Technical Support

### 6.1. Downloads

Downloads will be made available on the KiloVault website.

### 6.2. Documentation

Documentation can be downloaded from the KiloVault website: <https://kilovault.com/>

### 6.3. Contact Us

Email: [kilovault.support@altestore.com](mailto:kilovault.support@altestore.com)

Phone: +1 (877) 878-4060

KiloVault, LLC

330 Codman Hill Road

Boxborough, MA 01719