

# LORENTZ

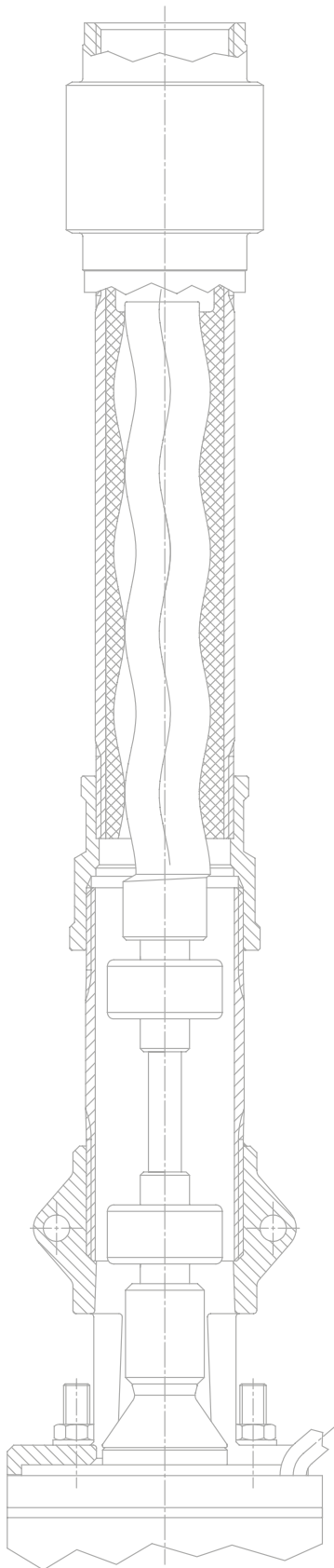
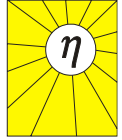

## PS200

## PS600

## PS1200

### SOLAR WATER PUMP SYSTEMS

### INSTRUCTIONS FOR INSTALLATION OPERATION SERVICE

For more information  
please contact your installer or:

Dankoff Solar Products, Inc  
Santa Fe, NM 87507

[www.dankoffsolar.com](http://www.dankoffsolar.com)  
[info@dankoffsolar.com](mailto:info@dankoffsolar.com)

Tel. 505-473-3800  
Fax 505-473-3830

release 05/01/10

# Contents

<b>1</b>	<b>WARNINGS</b> .....	<b>4</b>
<b>2</b>	<b>SYSTEM REPORT FORM</b> .....	<b>5</b>
<b>3</b>	<b>INTRODUCTION</b> .....	<b>8</b>
	<b>PHOTO GALLERY</b> .....	<b>9</b>
<b>4</b>	<b>INSTALLING THE SOLAR ARRAY</b> .....	<b>11</b>
4.1	Location of the Solar Array .....	11
4.2	Solar Array Assembly Methods .....	11
4.3	Solar Array Mounting Rack .....	11
4.4	Orienting the Solar Array to Solar South .....	12
4.5	Setting the Solar Array Tilt Angle .....	13
<b>5</b>	<b>ELECTRICAL INSTALLATION</b> .....	<b>14</b>
5.1	Controller, Junction Box, and Conduit .....	14
5.2	Grounding and Lightning Protection .....	16
5.3	Solar Array Wiring .....	18
5.4	Solar Array Disconnect Switch in the Junction Box .....	19
5.5	Junction Box (Controller Input) Wiring .....	20
5.6	Maximum RPM Setting .....	21
5.7	Submersible Pump Cable and Splice .....	22
5.8	Wiring Order for Correct Rotation .....	23
5.9	Low-Water Probe for Dry-Run Protection .....	24
5.10	Automatic Control For Full-Tank Shutoff .....	25
5.11	Battery-Based Systems .....	27
5.12	Pressurizing Systems .....	28
<b>6</b>	<b>PREPARING TO INSTALL THE PUMP</b> .....	<b>30</b>
6.1	WARNINGS about Handling Helical Rotor Pumps .....	30
6.2	Drop Pipe .....	31
6.2	Safety Rope and Binding .....	32
6.4	Installation in a Surface Water Source .....	33
6.5	Deep Well Setting — How Deep? .....	34
6.6	Coping with Dirty Water Conditions .....	34
6.7	Utilizing a Low-Production Water Source .....	35
6.8	Installing the Pump Under a Windmill or Hand Pump Cylinder .....	35
<b>7</b>	<b>IN-WELL ASSEMBLY AND INSTALLATION</b> .....	<b>36</b>
7.1	Rubber Spacers (Models -07, -10, -14, -20 only) .....	36
7.2	Machine Installation .....	37
7.3	Hand Installation .....	37
7.4	Sanitizing the Well .....	38
<b>8</b>	<b>OPERATING THE PUMP</b> .....	<b>39</b>
<b>9</b>	<b>TROUBLE SHOOTING</b> .....	<b>41</b>
9.1	If The Pump Doesn't Run .....	41
9.2	Inspect The System .....	42
9.3	Electrical Testing .....	43
9.3.1	Table of AC running current for PS200 and PS600 systems .....	44
9.3.2	Table of AC running current for PS1200 systems .....	44
9.4	If The Pump Runs But Flow Is Less Than Normal .....	46
9.5	Problem Report Form .....	47
9.6	Electrical Testing Illustrated .....	50

Contents continued

<b>10</b>	<b>MAINTENANCE</b> .....	<b>54</b>
10.1	Controller and Pump .....	54
10.2	Solar Array .....	54
10.3	Electrical Wiring .....	54
<b>11</b>	<b>MANUFACTURER'S WARRANTY</b> .....	<b>55</b>
<b>12</b>	<b>STANDARDS, ENVIRONMENTAL AND TEMPERATURE SPECIFICATIONS</b> .....	<b>55</b>
<b>13</b>	<b>REFERENCE SECTION</b> .....	<b>56</b>
13.1	Principles of Operation .....	56
13.2	Water Pipe Sizing Chart .....	58
13.3	Wellhead Assemblies for Drilled Wells .....	59
13.4	Water Storage for Solar Water Pumps .....	60
13.5	Monitoring a Solar Pump System .....	61
13.6	Freeze Protection for Solar Water Pumps .....	61
13.7	Selecting and Using Meters for Electrical Testing .....	62
13.8	Measuring Solar Energy Intensity .....	62
13.9	Glossary of Solar Electricity and Water Pumping .....	63
13.10	Calculating Pumping Efficiency and Power Requirement .....	67
13.11	System Wiring Diagram for Solar-direct (non-battery) System .....	68

**Symbols**



**WARNING**

disregard might lead to injury or damage the installation



**CAUTION**

recommended to avoid disfunction or premature ageing of the pump etc.



**QUESTION AND ANSWER**

gives explanation



**ADVICE**

## 1 WARNINGS

Open circuit (no-load) voltage above 100V for PS200-, above 150V for PS600- and above 200V for PS1200 controllers will destroy the controller. This may occur if the solar array is wired incorrectly. (See Solar Array Wiring, Section 5.3.)

Do not attempt to run the Motor without the PSXXX controller.

Do not attempt to use the controller for any purpose other than LORENTZ PS-Pump Systems.

To be installed, connected and serviced by qualified personnel only. Ensure all power sources are disconnected when making connections. Follow all appropriate electrical codes. There are no user serviceable parts inside the motor or the controller.

Solar pumps run at low flow rates, and have closer tolerances than conventional pumps. Extreme sand or silt concentration (greater than 2% by volume) may cause the pump to stop, or the pipe to fill with sand. Do not use *the pumps* to clean out a dirty well. (See Section 6.6. for advice about dirty water.)

Helical rotor pumps are sensitive to heat. Protect the pump from sunshine or other source of heat, or it may lock temporarily. If the water source is, or will be warmer than 72° (22°C), a special model may be required. (See Section 6.4.)

Undersized wire will cause failure to start. (See Section 5.7.)

Install proper system grounding for safety and lightning protection (See Section 5.2)

Do not touch the controller input or pump wires together to test for a spark.

Do not run the pump dry. Exception: to test direction of rotation, for maximum 15 seconds (See Section 5.8)

Test the direction of motor rotation before installing the pump (counter-clockwise looking down). If direction is reversed, exchange the connection of any two of the three power wires to the pump. (See Section 5.8)

When pump is stopped by a shadow or by action of float switch, it will restart after a 120 seconds.

The low water probe must be submersed, or the pump will stop for 20 minutes. If the probe is not to be used, connect the probe terminals together in the junction box. (See section 5.5 and 5.9)

Helical rotor models (without a C in the model #) are not self-draining. If drainage is required for freeze-protection, install a weep hole or draining device below freeze level. See Section 13.6 Do not remove the check valve in attempt to make it self-drain.



**Failure to follow these instructions will void the warranty.**

---

Install this system in accordance with local regulations and accepted codes of professional practice.

This manual is the property of the *LORENTZ Pump* owner.

Please give it to the owner or maintenance personnel when you are finished!

Request copies from your *pump* supplier or download from [www.Lorentz.de](http://www.Lorentz.de)

This manual is for controller models PS1200, PS600, PS200 as illustrated on the cover. For earlier models (before July 2003) refer to Version 1 and 2

Copyright © 2002-2004 by BERNT LORENTZ GMBH & CO KG and DANKOFF SOLAR PRODUCTS, INC. All rights reserved

## 2 SYSTEM REPORT FORM

### System and Components

System Voltage  V

Date of Purchase

Purchased from

Battery System?  yes  no

if not: Quantity of Solar Modules (panels)

Solar Module Brand

Module Model #

Controller Model  PS1200  
 PS600  
 PS200  
 other, i.e.:

Controller Serial #

Pump End Model #

Pump End Serial #

### Temperature Range

Helical rotor pumps (without C in the model number) work optimally only in a specific temperature range. Last digit of Pump End Model # indicates temperature class. If a special temperature range was not specified, the last digit of model number (X) will be 1.

*See Section 12 for more about temperature specifications.*

- Class 0 32 °F to 54 °F 0 °C to 12 °C
- Class 1 46 °F to 72 °F 8 °C to 22 °C **Class 1 is the standard class.**
- Class 2 64 °F to 90 °F 18 °C to 32 °C
- Class 3 82 °F to 108 °F 28 °C to 42 °C
- Class 4 100 °F to 126 °F 38 °C to 52 °C

System Report Form continued

## Installation Report

Installation Date

by

Well Depth

m / ft

Pump depth

m / ft

Additional Vertical Lift (up to top of tank)

m / ft

Static Water Level

m / ft

Drawdown level

m / ft

Drop Pipe (vertical from the pump)

Size

mm<sup>2</sup> / inch

Type

Length

m / ft

Additional Pipe Length (to tank)

Size

mm<sup>2</sup> / inch

Type

Length

m / ft

Submersible Pump Cable

Wire size

mm<sup>2</sup> / AWG

Total Length (controller to pump)

m / ft

### MAX RPM CONTROL

(See Section 5.6) Factory setting is Maximum.

yes

no

If this setting was reduced, enter setting here:

*System Report Form continued*

### **Performance Report**

When the pump is operating, record this data. This will help you to assess its performance and diagnose any problems that may occur in the future.

Flow rate observed

US-Gal./min / lpm

Notes

AC current through any one pump wire  
(See Section 13.7)

Amps

If these measurements were not taken  
at full vertical lift, note here

### 3 INTRODUCTION

**Thank you for purchasing a LORENTZ PUMP.** We set a new standard for quality and economy in solar pumping. It incorporates the best solar pump technologies that were very expensive until its introduction in 2002.

**Before you begin** Check the model numbers of all the components of your system, and verify that they are the items that you ordered. Also check against the *PUMP* specifications and performance charts (end of this manual) to be sure the system is appropriate for your application. If you expect to pump water that is very cold or very warm, check the “temperature range” specifications (Section 12). If you think you may have the wrong pump for your application, call your supplier immediately.

**Please fill in the SYSTEM REPORT.** This will be essential information if any problems occur.

**This manual covers two types of systems, battery and solar-direct.** If you purchased the *Pump* to connect to a battery system, you can skip the sections about the solar array and solar-direct systems.

**REFERENCE SECTION (Section 13)** Many installers are new to solar pumping, so we provide helpful information—principles of operation, instructions for wellhead assembly, water storage, control and monitoring of water supply, pipe sizing, freeze protection, and a glossary of technical terms.



## PHOTO GALLERY



### A MODEL INSTALLATION

A PS600 300Wp solar-direct system  
Colorado, USA

This system was installed by students in a solar water pumping class.

- The array is set at summer tilt angle.
- The controller is mounted on the north side of the pole, directly under the array. This shades it from the hot mid-day sun.
- Mounting and ground-bonding details are shown in Section 5.1.
- Electrical conduit runs from the *PUMP* junction box to the wellhead to protect the pump wires. The water pipe is all under ground.

Courtesy of Dankoff Solar Products, NM, USA



*Setting an array pole in concrete.*

Courtesy of Dankoff Solar Products, NM, USA



*This PV array was assembled and wired on the ground, then lifted with a crane.*

Courtesy of Dankoff Solar Products, NM, USA

*PS600 HR04-300Wp system in Colorado, USA, installed by students in a solar pumping class.*

*The drop pipe is 0.75" polyethylene. Hand installation requires caution and is not always recommended (see Section 7.3)*

Courtesy of Dankoff Solar Products NM, USA



*PV array assembly. The mounting pole is short enough to facilitate assembly without mechanical assistance.*

Courtesy of Dankoff Solar Products, NM, USA

*Owners of a domestic water system watch as the pump fills their polyethylene storage tank. The tank was buried later.*

Photo courtesy of Dankoff Solar Products, NM, USA



*A tracking solar array*

*The mounting pipe was extended to 11 feet (3 m), by welding it to a larger pipe. Wire is type USE (outdoor rated). The wire is looped to help it to shed water and to flex. Wires enter the conduit through a “weather head”.*

Courtesy of Dankoff Solar Products, NM, USA

## 4 INSTALLING THE SOLAR ARRAY

### 4.1 Location of the Solar Array

Sunlight is the “fuel” that drives a solar pump. Full solar exposure of the solar array is critical for full performance of a solar-direct system.

Choose a location for the solar array that has unrestricted sun exposure through the day and through the year. The array can be placed several hundred feet (100 m) or more from the wellhead. There will be no loss of performance if the electrical wire is sized properly, but naturally, the cost of wire will increase significantly. The System Sizing Table specifies wire size requirements for both normal and extended wire lengths.



**CAUTION** Shading a small portion of a PV array may cause the pump to stop completely.

Each PV module (panel) contains a series of solar cells (typically 36 or 72 cells). Every cell that is shaded acts like a resistor, reducing the output of the ENTIRE ARRAY. Shading just a few cells will reduce the power disproportionately, and may stop the pump. Consider this when deciding where to install the array.

To determine where shadows may be cast at any time of the year, you can survey the site with a *Solar Pathfinder*<sup>®</sup>. This device is especially useful in forested areas or wherever there are obstructions nearby. It is available directly from Solar Pathfinder (USA) tel. (317) 501-2529, fax (931) 590-5400, [www.solarpathfinder.com](http://www.solarpathfinder.com).

Place the bottom edge of the array at least 2 feet (.6 m) above ground to clear rain spatter, growing vegetation and snow. Keep in mind that trees and perennial plants will grow taller in the coming years.

### 4.2 Solar Array Assembly Methods

There are two ways to install the solar array.

1. Assemble the array on the ground, wiring and all, then lift the entire assembly onto the pole or roof. A system of 300 watts or more may require the assistance of a backhoe, boom truck or crane to lift it over the pole.
2. Assemble the array piece-by-piece on the pole. If the pole is higher than about 6 feet (2m), it is best to construct a temporary platform, like a scaffold assembly commonly used in building construction). A scaffold system can be rented from a local supplier.

### 4.3 Solar Array Mounting Rack



**WARNING** Your mounting structure must be engineered for wind resistance and safety.

**Follow the rack (or tracker) manufacturer’s instructions that are packed with your rack.**

**Solar Tracking** A solar tracker is a special pole-mounted solar array rack that tilts automatically to follow the daily path of the sun. In clear summer weather, it can increase your daily water yield by 40-50%. (It is much less effective in winter and in cloudy weather.)

## 4.4 Orienting the Solar Array to Solar South

For full performance, your solar array must be oriented within  $10^\circ$  of true (solar) south. Depending on your location, a compass reading may show an error of as much as  $20^\circ$ . To correct this discrepancy, apply the magnetic declination for your region. Many regional maps indicate the magnetic declination. If you don't have a compass but can see your shadow and know the time of day, use the **Sun Compass™**.

### SUN COMPASS

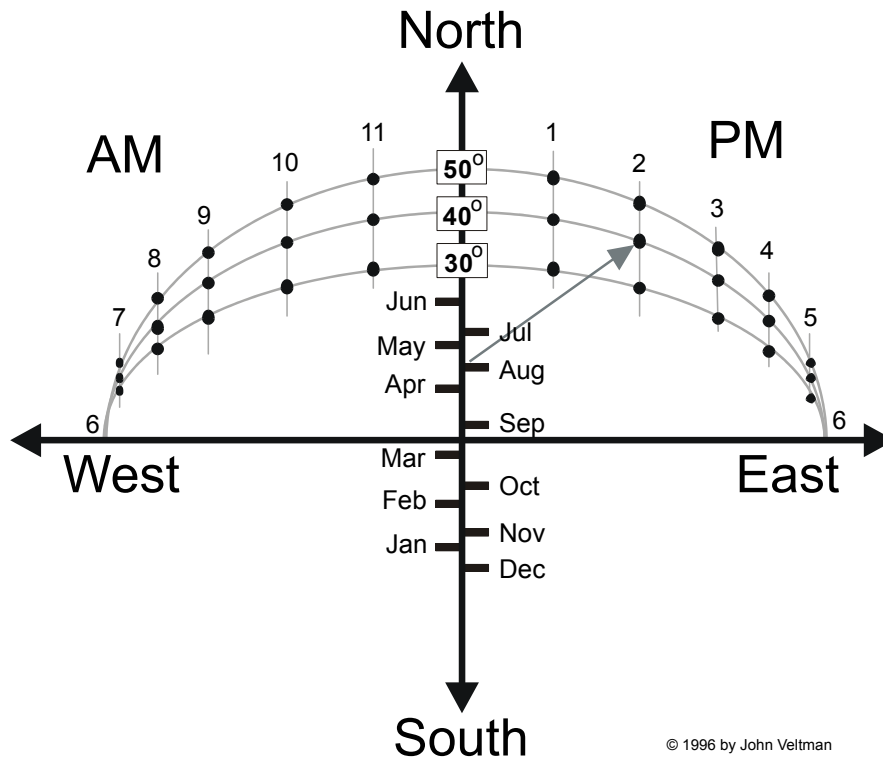

For the USA  
(lower 48 states)  
and other  $25^\circ$  to  
 $55^\circ$  North latitude  
regions.

**Find True South**  
quickly and  
accurately using  
only your shadow.  
No magnetic  
compass needed!

© 1996 by John Veltman

#### Sun Compass Instructions

1. Draw an arrow from Month dot to intersection of your *Standard Time* and Latitude Northern ( $50^\circ$  N to  $70^\circ$  N)  
The gray line is an example: August, 2 PM at  $40^\circ$  N lat.
2. Stand and face your shadow.
3. Hold this page horizontally.
4. Point the arrow that you drew to center of your shadow.
5. Sun Compass now points to the four directions.

**Sun Compass™** is available for the following latitudes:

1. U.S.A. ( $25^\circ$  to  $55^\circ$ ) – shown here
2. Northern ( $50^\circ$  N to  $70^\circ$  N)
3. Equatorial ( $20^\circ$  N to  $20^\circ$  S)
4. Southern ( $10^\circ$  S to  $40^\circ$  S)

To obtain reproduction rights, contact: John Veltman PO Box 23533, Santa Fe, NM 87502 USA



## 4.5 Setting the Solar Array Tilt Angle

Maximum performance is obtained from a solar pump when its photovoltaic array is tilted (elevated) to face the sun. The solar array racks that are supplied with *the Pump Systems* are adjustable to the desired tilt angle. It is the responsibility of the installer to perform this adjustment.

Some *systems* include a solar tracker, and others with a fixed (non-tracking) rack. Both types of array have a manual tilt-angle adjustment. (The tracker follows the daily path of the sun, but not the seasonal tilt variation.)

The optimum tilt angle is determined by the location (latitude). It also varies with the time of the year. This data is presented in the table below.

Should the tilt angle be adjusted periodically through the year? This depends on the seasonal water-use pattern, and also on human factors. There are three options to choose from.

### Select one of these options for seasonal management:

**1. Year-round compromise** (no seasonal adjustment) Set the angle equal to the latitude of the location and “forget it”. This is practical because people often forget to adjust the array. The performance displayed in the **System Sizing Table** is based on this fixed compromise setting of the tilt-angle.

**2. Seasonally adjusted** It is sufficient to perform the adjustment only twice per year, at the spring and autumn equinoxes, to the summer and winter angles indicated below. For central USA, this will increase the daily water production by about 8% in summer, 5% in winter compared to option 1.

**3. Seasonal use only** If the pump is to be used no more than half of the year, set the array to the appropriate seasonal angle shown below, and “forget it”.

If you use the pump all year but do not want seasonal adjustment to be required, set the angle to *year-round compromise* (equal to latitude).

Location (examples)	Latitude	Summer Tilt	Winter Tilt	Year-Round Compromise Tilt
Southern Canada	50°	35°	65°	50°
Upper Third of USA	45°	30°	60°	45°
Middle Third of USA	40°	25°	55°	40°
Lower Third of USA	35°	20°	50°	35°
Central Mexico	20°	5°	35°	20°

### Solar Array Tilt Angles by Latitude



*0-25° latitudes: Apply a minimum tilt angle of 10°, or dust and debris will accumulate.*



**CAUTION** People often forget to make seasonal adjustments.

**Ideal angles (from horizontal) are:**

Summer optimum = latitude - 15°

Winter optimum = latitude + 15°

## 5 ELECTRICAL INSTALLATION

### 5.1 Controller, Junction Box, and Conduit

**Location** Place the controller close to the solar array, not the pump. This will reduce the risk of lightning damage.

**Explanation** — The controller's input circuitry is more sensitive to surges than its output. It is safest to minimize the length of the input wiring.

**Protection from solar heat** Electronic devices are most reliable when they are protected from heat. Mount the controller in the shade of the mid-day sun. An ideal location is directly under the solar array, on the north side of the mounting pole. If shade is not available, cut a piece of sheet metal and bolt it behind the top of the controller. Bend it over the controller to provide shade. This is especially important in extremely hot locations. Extreme heat may trigger a thermal switch in the controller and cause it to turn off.

**Location of controller** Mount the controller vertically to keep out rainwater. It is preferable to mount it ON THE NORTH SIDE of a pole or other structure, to help reduce solar heating. This may also allow easiest access without hitting your head on the lower (south) edge of the array.

**Junction Box (optionally)** A pre-wired junction box is available for your system. The junction box terminals will handle pump wires as large as #6 (13 sq. mm). If large wires cannot be accommodated easily in the box, you can join them to smaller wires in the junction box. #12 (4 sq. mm) or larger is acceptable for this very short length. Do NOT remove terminal screws. If the key to the junction box gets lost, it can be opened with a screwdriver.

**Mounting the controller and junction box to a pole** See photos on the following page. The controller can be mounted onto the solar array support pole using materials available from your local electric supply store. The best mounting hardware is "slotted strut" (*Unistrut*<sup>®</sup> or equivalent) with matching conduit clamps to fit around the mounting pole. This makes a very strong assembly that is easy to adjust. In North America, these materials are commonly available from electric suppliers.

**Electrical conduit is recommended** We urge you to use electrical conduit (pipe) to protect outdoor wiring from the weather, from human activities, and from chewing animals. See photos on the following pages. If you don't use conduit, use strong, high-quality outdoor cable. Where cables enter the junction box, install sealed strain-relief cable clamps.

**Keep the controller and junction box sealed** Unused holes must be sealed to keep out animals, insects, water and dirt. Each hole is supplied with a rubber plug that can be kept in place for this purpose.

**Battery system** Batteries must be in a cool location for best longevity, and in a protective enclosure for cleanliness and safety. Place the controller near the batteries but NOT in the same enclosure. They must be safely isolated from the battery terminals and from corrosive gasses.



**WARNING** To be installed, connected and serviced by qualified personnel only. Ensure all power sources are disconnected when making connections to the controller. Follow all appropriate electrical codes. There are no user serviceable parts inside the motor or the controller.



**CAUTION** Loose connections are the most common cause of system failures.

Pull on each connection to confirm that it is secure.

*Controller, Junction Box, and Conduit continued*

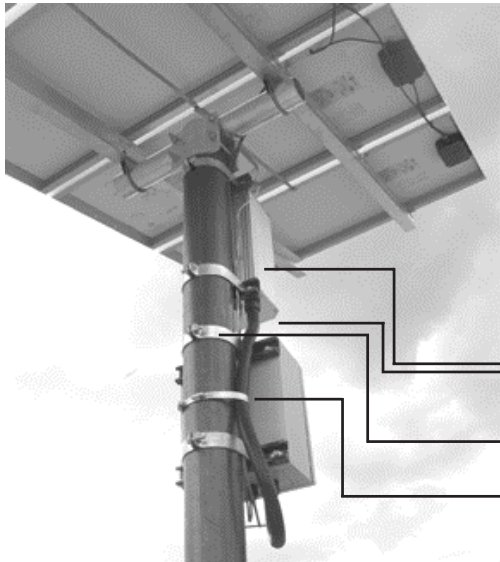

**Typical assembly** of controller and junction box on the solar array mounting pole. Boxes are secured using slotted strut and conduit clamps.

Bare ground wires bond the PV modules to the controller enclosure, and continue down to the ground rod. Flat braid is flexible and eliminates the need for terminal lugs.



*Mount the controller on the north side of the pole to reduce solar heating.*

slotted strut (*Unistrut*® or equivalent), cut to the width of the box.

conduit clamp to fit slotted strut

hose clamp



**Conduit holes**

3 holes for 3/4" conduit (28mm)

1 hole for 1 1/4" conduit (45mm)

Holes are in a removable plate that can be reversed.

Rubber plugs are included for unused holes.

## 5.2 Grounding and Lightning Protection

Surges induced by lightning are one of the most common causes of electronic controller failures in solar water pumps. Damaging surges can be induced from lightning that strikes a long distance from the system, or even between clouds. The risk of damage is greatly reduced if these instructions are followed.

**Location of the pump controller** Place the controller close to the solar array, not the pump. This will reduce the risk of lightning damage. Explanation: The controller's input circuitry is more sensitive to surges than its output. It is safest to minimize the length of the input wiring.

**Construct a discharge path to ground** A properly made discharge path to ground (earth) will discharge static electricity that accumulates in the above-ground structure. This helps prevent the attraction of lightning. If a lightning strike occurs at close proximity, a well-grounded conductive structure can divert the surge AROUND the electrical circuitry, greatly reducing the potential for damage. The controller has built-in surge protectors, but they help ONLY if the system is effectively grounded.

**Earth connection – Create an effective discharge path** It helps to picture this as a “drain field” for electrons. Here are suggestions for grounding, in order of their efficacy:

1. The best possible ground rod is a steel well casing located near the array. Drill and tap a hole to make a strong bolted connection to the casing with good metallic contact. Bolt on a brass terminal lug. After the connection is made, seal the connection with silicone sealant or other waterproof compound to prevent corrosion. Protect the ground wire(s) from physical damage so they aren't stressed by being stepped on, etc.
2. Install a copper plate or other specialized grounding devices designed for the purpose. Some systems use salts to improve the conductivity of the surrounding soil.
3. Install one or more copper-plated ground rods at least 8 feet (2.5m) long, preferably in moist earth. Where the ground gets very dry (poorly conductive), install more than one rod, spaced at least 10 feet (3m) apart.

4. If the soil is rocky and doesn't allow ground rods to be driven, bury BARE copper wire in a trench at least 100 feet (30m) long. If a trench is to be dug for burial of water pipes, ground wire can be run along the bottom of the trench. The wire size must be minimum #6 (16 sq. mm) or double #8 (10 sq. mm). Connect one end to the array structure and controller. Or, cut the ground wire shorter and spread it in more than one direction.

**Dry or rocky locations** To achieve good grounding at a dry or rocky site, consult a local contractor who specializes in lightning protection. It is best to plan the procedure in advance, and to coordinate the effort with other earth-excavating procedures that need to be done. Reference: [www.lightning.org](http://www.lightning.org)

**Bond (interconnect) all the metal structural components and electrical enclosures** Interconnect the PV module (solar panel) frames, the mounting rack, and the ground terminals of the disconnect switch and the controller, using wire of minimum size #8 (6mm<sup>2</sup>), and run the wire to an earth connection.

**Ground connections at the controller** The controller and junction box have redundant ground terminals inside. They are all connected in common with the metal enclosures of both the controller and the junction box. Ground connections can be made to any of these points.

**Ground connections to aluminum** This applies to connections at the solar array framework, and at the controller's enclosure box. Connections to aluminum must be made using terminal lugs that have an aluminum-to-copper rating (labeled “AL/CU”) and stainless steel fasteners. This will reduce the potential for corrosion.



**WARNING**  
**Failure to install and connect an effective grounding system will greatly increase the risk of lightning damage and will void your warranty.**  
*We suggest you wire the grounding system FIRST so it is not overlooked. The concrete footer of a ground-mounted array will NOT provide adequate electrical grounding.*



## Grounding and Lightning Protection continued

**DO NOT GROUND the positive or the negative of the power circuit.** The best lightning protection results from grounding the metallic structure only, and leaving the power system ungrounded. This is called a “floating” system.

**Explanation:** With a floating system and a good structural ground, lightning induced surges tend to reach ground through the structure, instead of the power circuit. When high voltage is induced in the power circuit, the voltage in negative and the positive sides tend to be nearly equal, thus the voltage BETWEEN the two is not so high, and not usually destructive. This method has been favored for many decades by most engineers in the remote power and telecommunications fields.

**Exception for battery systems:** You can connect the pump to a battery-based home power system that has a negative ground. If the wiring distance to the pump exceeds 100 feet (particularly in a high lightning area), DC-rated surge protection devices are recommended.

**Legal exception:** If the local electrical authority requires grounding of the power circuit, ground the PV ARRAY NEGATIVE wire. This may increase the risk of lightning damage.

**Solar array wiring** Bind the array wires close together, or use multi-wire cable. Avoid forming loops. This helps induced voltages in each side of the circuit to equalize and cancel each other out.

**Wire twisting for long runs** Twisting wires together tends to equalize the voltage induced by lightning. It reduces the voltage differential between the wires. This reduces the probability of damage. This method is employed in telephone cable, and in many other applications. Some power cables are made with twisted conductors. To twist wires yourself, you can alternate the direction of the twist about every 30 feet (10 m). This makes the job much easier.

**Float switch cable** A long run of control cable to a float switch in the storage tank can pick up damaging surges from nearby lightning. The best protection is to use shielded, twisted-pair cable. Shielded cable has a metallic foil or braid surrounding the two wires. Ground the cable shield as illustrated in Section 5.10.

**Low water probe cable** A long horizontal run of wire to the low-water probe at the pump can pick up damaging surges from nearby lightning. Wire twisting is helpful. The best protection is to use shielded, twisted-pair cable, same as recommended for a remote float switch. This product is suitable for direct burial, but not for submersion in the well. At the wellhead, make a transition to submersible probe wires.

**Additional lightning protection** The controller has built-in surge protection devices. However, additional grounding measures or surge protection devices are recommended under any of the following conditions:

1. Isolated location on high ground in a severe lightning area
2. Dry, rocky, or otherwise poorly conductive soil
3. Long wire run (more than 100 feet / 30m) from the controller to the wellhead, or to the float switch.

Additional lightning protection devices (surge arrestors) can be obtained from your pump supplier. The device(s) for the controller’s PV input, float switch and probe connections, must be rated for DC. The device(s) for the controller’s AC output to the motor must be rated for 3-phase AC. In each case, the clamping (bypass) voltage should be 90V or higher, but not much higher.

In extreme cases, it is best to employ the service of a local lightning protection contractor.

**Reference** [www.lightning.org](http://www.lightning.org)



**CAUTION**  
**Ground the cable shield at the controller end only, not at the float switch.**



**WARNING**  
**Isolate solar pump wiring from electric fence systems.**  
*Do not connect the pump system to the same ground rod as an electric fence. Do not run power or float switch cables close to an electric fence.*

## 5.3 Solar Array Wiring

The solar array can produce hazardous voltage even under low light exposure. To prevent shock hazard while wiring the array, leave one or more wires disconnected or cover it with opaque material.

Solar-direct (non-battery) systems use a variety of array configurations. Some use 12V (nominal) modules, and some use 24V modules. Modules are connected in series for 24 - 36 - 48V and up to 96V (for PS1200 Systems), and sometimes also in parallel to increase the current. **Refer to the System Wiring Diagram** for your system, attached at the end of this manual. Be sure the modules (panels) match the description on your System Wiring Diagram.

**Solar module connections** The terminals in the module junction boxes can be confusing. Refer to the module manufacturer's instructions that are packed with the modules. Make strong connections that will hold for many years. Most array failures are caused by loose, corroded, or shorted connections.

**Type of wire** Use either electrical conduit or outdoor UV-resistant wire. The solar array has a life expectancy beyond twenty years. Don't degrade it with inferior materials! Use minimum wire size #12 (4 sq. mm) for the connections between modules and for short distances to the controller. Some appropriate types of wire are: USE, UF, SE and SOOW.

**Solar tracker wiring** If you are installing a solar tracker, pay careful attention to the wire section that leads from the moving rack down to the stationary mounting pipe. Use a highly flexible wiring assembly. Form a drip loop to shed water and to minimize stress. SEE TRACKER PHOTO and caption in the PHOTO GALLERY. Secure the assembly mechanically at each end so the insulation and the connections are not stressed by the tracker's motion. Swing the tracker fully in each direction, at various seasonal tilt angles, to verify that the cable will not rub or restrict the tracking motion.

**MC connectors** Some PV modules have these quick connectors. If the connector is not appropriate at some junctions, you can cut the wire and make a conventional connection.

2 types of PV module junction systems

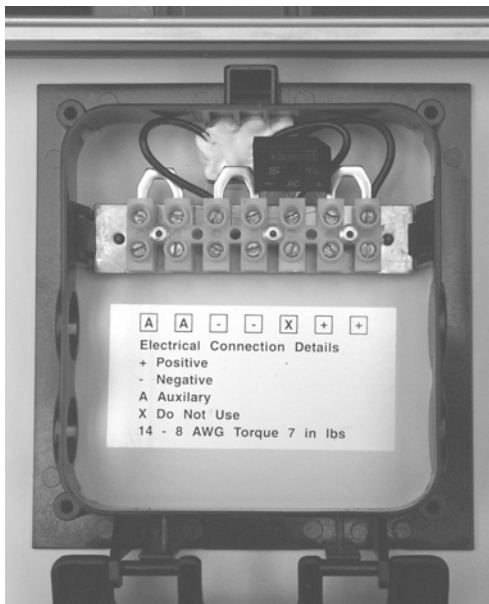

**TOP** Quick-connect system using "MC" connectors.

**BOTTOM** Junction box with screw terminals and conduit holes



**WARNING:** The photovoltaic array generates hazardous voltages. A 48 Volt (nominal) array can generate nearly 100 volts when disconnected from load. A short circuit or loose connection will produce an arc that can cause serious burns. All wiring must be done by qualified personnel, in compliance with local, state, and national electrical codes.

### 5.4 Solar Array Disconnect Switch in the Junction Box

The disconnect switch satisfies National Electrical Code requirements for a safety disconnect between the solar array and the controller. During installation and maintenance, switch off the disconnect switch to prevent shock and arc burn hazard.

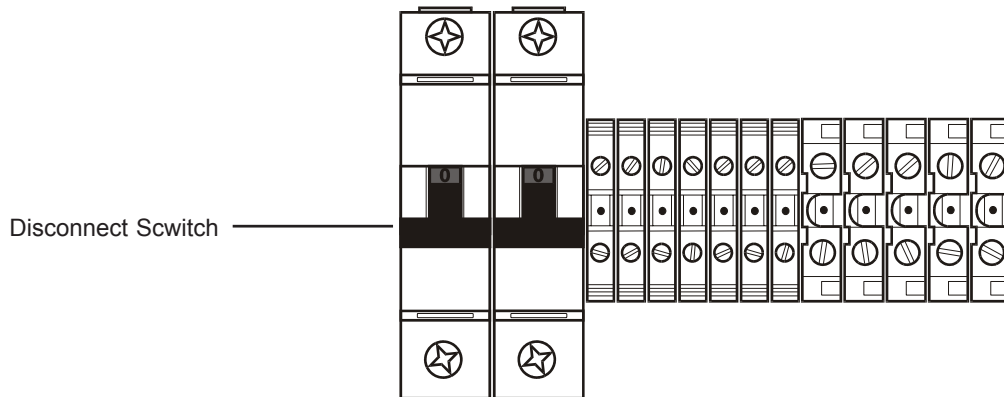

**CAUTION** Loose connections are a common cause of failure. Pull each connection to confirm.

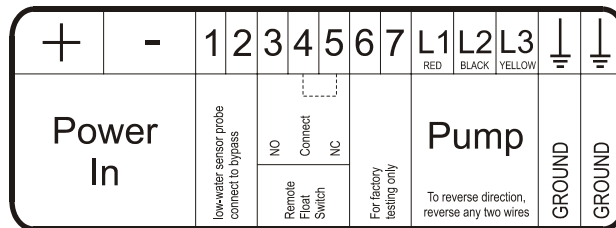

**CAUTION** If you are not using a low-water probe, connect a small wire between terminals 1 and 2.

**Note:** Overload protection (fuses or circuit breaker) is NOT required in the solar array circuit.

**Explanation:**

1. Short circuit current from the solar array can never reach the ampacity (maximum safe amps capacity) of the recommended wire.
2. The PS- controller has internal overload protection.

## 5.5 Junction Box (Controller Input) Wiring



**WARNING TEST THE VOLTAGE** before connecting power to the controller. Voltage (open circuit) must not exceed 100V for PS200-, 150V for PS600 and 200V for PS1200 systems. (Even in cloudy weather, the open circuit voltage will be near maximum.)

**WARNING** Do not apply a direct connection or an amp meter between + and – when the controller is connected. A short circuit here will cause a strong discharge.

**WARNING SOLAR-DIRECT systems only —** Do not connect any electrical load to the solar array if it is not part of the **LORENTZ Pump system**. Connection of a battery charger, active solar tracker controller, electric fence charger, or other load simultaneously with **LORENTZ PS systems** may “confuse” the controller and prevent proper operation.

**System Diagram** For solar-direct systems, refer to the System Diagram at the end of this manual.

**Ground connections** The two ground terminals in the junction box are bonded together and are also bonded to the metallic enclosures of both the junction box and the controller. See Section 5.2

**POWER IN** Ensure that the solar array DISCONNECT SWITCH (or battery fuse or circuit breaker)- is OFF. Connect the power from the solar array to the input terminals in the junction box. Observe polarity. If your wires are not clearly marked +/-, test them using a DC voltmeter or multimeter.

**PUMP** See Section 5.8.

**Low Water Probe** See Section 5.9

**Float Switch** See Section 5.10, Automatic Control for Full-Tank Shutoff. A connection is made at the factory between terminals 4 and 5. If you are NOT using a float switch, leave this connection in place.



**CAUTION** If you are not using a low-water probe, connect a small wire between terminals 1 and 2.

## 5.6 Maximum RPM Setting

All PSXXX controller offer the option of reducing the maximum speed of the pump.

This RPM control reduces the maximum speed (RPM limit) to as low as about 30%. It will NOT reduce the starting or low-light performance. The pump uses less power when it pumps less water.

### Reasons to reduce the maximum RPM

1. To prevent over-pumping a limited water source (see Section 6.7)
2. To improve energy and water-source management in a battery system where slow pumping is adequate to meet the demand
3. To limit the back-pressure (and prevent possible pump overload) when pumping into a direct-pumped irrigation system, a filtration system, or an undersized pipeline

1. Remove the bottom end of the PS-XXX controller enclosure (the end with the conduit openings)

2. Locate the adjustment knob shown in the photo below (circled)

3. In most cases, the knob will be at the standard factory setting full clockwise as indicated by “setting #1” illustrated below. Turn it counter-clockwise to the desired setting. The exact positions may vary from this illustration. Follow the ink marks on the controller.



**CAUTION** If you perform this adjustment, record the setting on the System Report Form (Section 2). If flow testing is done in the future, the result may lead to a wrong conclusion if this adjustment is not accounted for.

### How to reset the Maximum RPM setting

### Terminals inside the PS-XXX controller.

“Max. RPM setting” is at right.

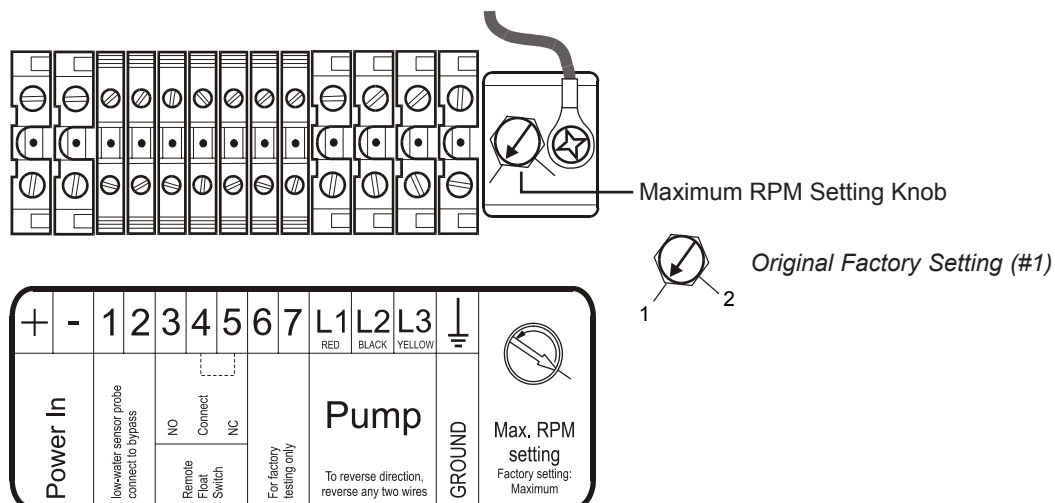

## 5.7 Submersible Pump Cable and Splice

**Selection of cable** Use only an approved type of submersible well pump cable, the same type that is used for conventional AC pumps. It is available from your *pump* supplier or installer, or a local water well supply distributor. You need 4-conductor cable. It is often called “3-wire-with-ground” because it has 3 power wires plus a ground wire. To determine the minimum required wire size, refer to the Systems Sizing Table.

**Submersible Splice** A splice kit includes crimp connectors to join the copper wires, adhesive heat-shrink tubing, and instructions. If the drop cable is too large to fit in the crimp connector, cut off some of the wire strands. Use a crimping tool, and observe that the wires are held very securely.

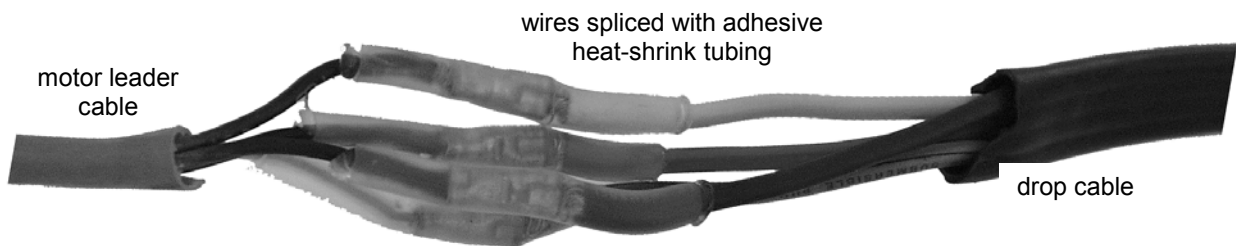



## 5.8 Wiring Order for Correct Rotation

The power wires on the pump are black with white lettering to indicate L1, L2 and L3. WRITE DOWN the colors that you splice to L1/ L2 / L3 so you can match them with the L1/ L2 / L3 terminals in the pump controller.

**If your pump cable has the standard RED, BLACK and YELLOW colors, use this sequence:**

RED	BLACK	YELLOW	GREEN
L1	L2	L3	Ground

**The power wires on the pump may also be brown-black-grey for Motors delivered Q2 2005. Then use brown as L1, black as L2 and grey as L3**

**Testing the pump for direction** Helical rotor pumps will produce water flow only if they are rotating in the right direction. If you place it in a water tank or a bucket, you will observe flow if the rotation is correct. (Submerge at least 75% to observe full flow).

**Alternative, dry test** If you don't have a water vessel to test the pump in, you can test it dry by watching the pump shaft and running it for only a few seconds. The metal label on the pump has an arrow to indicate the proper direction of rotation. If the pump is new from the factory, it is lubricated so it can run dry for about 90 seconds without risk. If the pump is not new, it can be run dry safely for about 15 seconds. Either way, this is more than enough time to observe the direction of the shaft.

If you did not write down the color match (or the wind blew your note away) connect the three power wires to the controller in ANY random order. Apply power. Observe the pump shaft rotation, then turn the power off. If

the direction is wrong, exchange ANY TWO of the power wires at the controller. In any case, when you are finished connecting the pump to the controller, test it to assure the proper direction.

**Did you install the pump in the well without checking the wiring order or the direction? OR – Is it running but not pumping?**

**HELICAL ROTOR pump (model number does NOT contain "C")** Turn the pump on. Observe if air is rising from the pipe. If it isn't, reverse any two motor wires and observe again. If you cannot observe air rise, chose whichever direction is quieter (less vibration). There is risk of dry-run damage if it runs too long in reverse. If the pump is new from the factory, it is lubricated so it can run dry for about 90 seconds without risk. If the pump has been used, it must not be run for more than about 15 seconds. In many cases, a pump that is reversed will turn off due to overload.

**CENTRIFUGAL pump (model with C in the name)** In reverse, it will produce no flow (or very little). This will NOT damage the pump. If the flow is not normal, reverse any two motor wires.

**Question** *The motor shaft is hard to turn by hand, and moves in a bumpy manner. Is this normal?*

**Answer** YES. This is caused by permanent magnets in the motor. It is especially hard to turn when it is connected to the controller, or if the pump wires are connected together.



**WARNING** *If the pump wires are in the wrong order, the motor will run in reverse and the pump will not function. Damage may result. Check the direction BEFORE installing the pump. The proper direction is COUNTER-CLOCKWISE when viewed from above.*



**WARNING** *When testing for direction, do not run the pump dry for more than 15 seconds.*



## 5.9 Low-Water Probe for Dry-Run Protection

**Installation** The probe is packed with two stainless steel hose clamps. For a pump that is to be installed in a vertical position, clamp it to the pipe just above the pump outlet, as shown in the photo. Splice the two probe wires using the splice kit components that are packed with the probe. The assembly procedure is the same as the main pump splice.

**If you are NOT using the well probe, it must be bypassed.** Connect a short wire between the probe terminals in the junction box (terminals 1 and 2). Do this only if you feel certain about the reliability of the water source. Wire size: #18 AWG (1mm<sup>2</sup>) or larger.

**Principle of operation** The probe contains a mechanical float with a magnet inside. When the probe is submerged, the float rises, and the magnet actuates a switch. The switch closes (makes contact) to indicate the presence of water. The switch is sealed, so the contacts never touch the water.

If the water level drops below the probe, the float drops, and the switch opens (breaks contact). The controller will stop the pump and the “Low-Water OFF” light will indicate. When the water level recovers and switch closes again, the controller will delay the restart for 20 minutes. This gives time for the water level to recover. To force a quick restart, turn the controller off, then on again.

**NOTE** Pumps made before October 2003 may have a different type of probe, with wet electrodes. Either type can be used with the PS-XXX series controllers.

The Low Water-OFF light flashes slowly for the remainder of the day, even if the water recovers and the pump restarts automatically. This tells you that the water source ran low at least once since the power was disrupted (or sun went down). To turn the light off, reset the controller by turning it off/on.

**Potential problems with the low-water probe in surface water** The probe has a moving float. It is highly resistant to deposits and debris. However, it may stick under some extreme conditions, especially from algae or water creatures (snails, etc.) that may be present in surface water. Possible solutions are:

1. Hang the probe independently of the pump and pipe (clamped to a weight, but not to the drop pipe). This way, it can be pulled up for inspection or cleaning without the need to pull the pump. (This may not be feasible if the well casing is smaller than 6".)
2. Pull the probe out periodically (with the pump if necessary) for testing and inspection. The pump should stop at the moment the probe leaves the water.
3. Wrap the probe in a protective screen (fiberglass window screen, for example).

Substitute a different type of float switch. You can use any switch that makes contact on rise (normally open).



**WARNING**  
Running completely dry will damage the pump and void the warranty. The purpose of the probe system is to sense the loss of water and turn the pump off before it can run dry.



**CAUTION** The low-water probe must be positioned vertically, within 10°. If the pump is NOT to be installed vertically, find an alternative way to mount or suspend the probe, so that it is higher than the pump, and in a vertical position.

*Low-water probe installed in the standard position, for a pump that is positioned vertically*



**CAUTION** Do not use a pressure switch with a “low water cutout” or “loss of prime” feature as a method of dry-run protection. A helical rotor pump will maintain pressure as it runs dry, so this method will not work reliably. For pressure switch information, see Section 5.12, Pressurizing Systems.



## 5.10 Automatic Control For Full-Tank Shutoff

We recommend the use of a float switch or other means to prevent overflow of your tank. This will stop the pump when the tank is full, then reset when the level drops. This conserves ground water, prevents overflow, and eliminates unnecessary pump wear. PS-XXX controllers allow the use of small signal cable to a remote float switch, even if the tank is a long distance away.

### Float switch requirements

1. A switch must be used, not wet electrodes.
2. The preferred system requires a float switch to MAKE contact on rise to turn the pump OFF. This is called “normally open” (N.O.). It may be commercially labeled as a “pump down” switch, but here it works in reverse, to allow pumping up.

### Float switch cable requirements

1. Two wires are needed.
2. Minimum wire size #18 AWG ( 1mm<sup>2</sup>). This is good for a distance as far as 2000 feet (600 m).
3. The cable must be suitable for its environment.
4. If it must run a long distance, use twisted-pair shielded cable to reduce the chance of damage from lightning-induced surge. (See Section 5.2 Grounding and Lightning Protection).

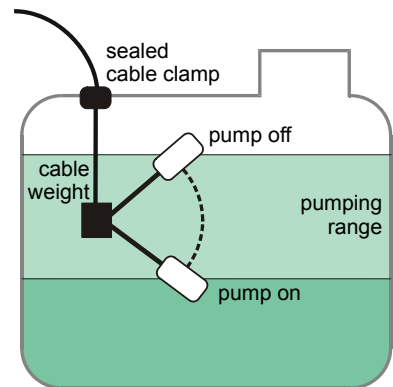

**Grounding shielded float switch cable** If you use shielded cable, connect the shield to ground AT THE CONTROLLER ONLY. DO NOT ground the shield at the float switch. This will reduce surges induced by nearby lightning.

**Wiring to the controller (junction box)** The controller (and junction box) offers two options for connection of a remote switch. These allow the use of either a “normally open” (N.O.) or a “normally closed” (N.C.) switch. “Normal” refers to the status of the contacts when the switch is DOWN and calling for water.

**Wiring a “normally open switch”** Connect the switch to terminals 3 and 4 (NO and common) and connect terminals 4 and 5 together, as illustrated. Closing (connecting) the switch circuit turns the pump OFF

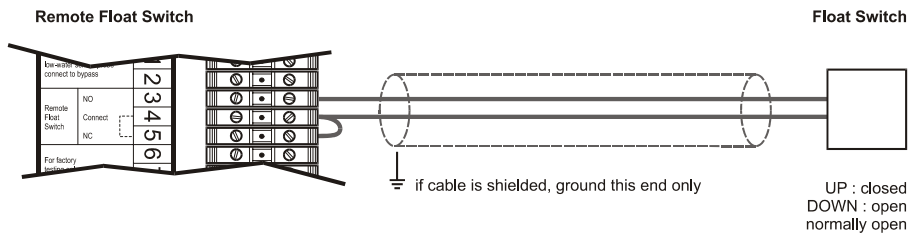

## Q+A

**QUESTION** Why do we use a reverse-action (N.O.) float switch? (a pump-down switch for a pump-up application)

**ANSWER** If the cable connection is broken, the pump will continue to operate. The water supply will not be disrupted (but of course, the tank will overflow). This is the general preference in the industry. If you prefer the pump to stop if the connection is broken, use a normally closed (N.C.) float switch instead.

**Wiring a “normally closed/reverse action switch”** Connect the switch to terminals 4 and 5. Closing (connecting) the switch turns the pump ON

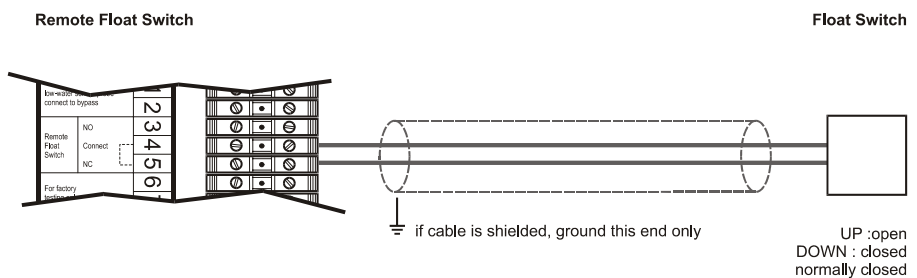

## Automatic Control For Full-Tank Shutoff continued

**If you are not using a float switch**, terminals 4 and 5 must be connected. Terminal 3 remains disconnected.

**Operation of the float switch system** When the water level is high, the float switch will stop the pump. The FULL-TANK OFF indicator on the controller will light up. When the water level drops, the float switch will signal the controller. The indicator light will go out, and the pump will restart if sufficient power is available.

**Overriding the float switch** You may want to override the float switch to allow overflow for irrigation purposes or to test or observe your system. For a N.O. switch circuit, install a switch to DISCONNECT ONE of the float switch wires. FOR A N.C. switch circuit, install a switch to CONNECT the two float switch wires together.

**WIRELESS ALTERNATIVE, using a float valve and pressure switch** It may be feasible to use a FLOAT VALVE in the water tank (instead of a float switch) for remote shutoff. This eliminates the need for a cable to the tank when the tank is a long distance from the pump system. When the tank fills, the valve shuts, causing pressure to rise at the pump. A pressure switch is installed at the wellhead (or at anywhere along the pipe). The pressure switch is wired to the *pump* controller, and adjusted to respond to the rise and fall of pressure. The assembly is similar to that of a normal pressurizing system. Refer to Section 5.12.

### CAUTIONS for the wireless alternative

1. The *pump* system must be capable of producing at least 25 PSI (60 feet, 18m) more than the full lift pressure. (A conventional pressure switch may not function reliably at a lower pressure differential.)
2. If the lift from the pressure switch up to the tank is to exceed 100 vertical feet (30m), the off-pressure may exceed the pressure ratings for normal components, which is typically 150 PSI (10 bar).
3. Pressure switch adjustments are critical. Be sure to observe carefully to verify the performance.
4. Install a pressure gauge near the pressure switch, to help you make adjustments.
5. Install a small pressure tank near the pressure switch. Without it, rapid start/stop cycling is likely to occur which is very undesirable. Any captive-air pressure tank of 2 gallons (8 ltr) or larger is sufficient.
6. Adjust the pressure tank pre-charge to a pressure slightly lower than the working pressure in the pipe. On level ground, the working pressure may be nearly zero. In that case, open the water-end of the pressure tank to the atmosphere and let out all the pre-charge air. (The air bladder must not collapse all the way.)
7. **WARNING** Install an appropriate pressure relief valve for safety (see Section 5.12).
8. Be sure the tank has a safe way to overflow if the float valve leaks, wire breaks, etc.
9. To prevent slow action of the float valve, and lots of on/off cycling, we recommend a quick-acting float valve. Source: Tek Supply, [www.teksupply.com](http://www.teksupply.com) (800) 835-7877, Item #WR-1300, or search "Hudson Valve".

**MANUAL REMOTE CONTROL SWITCH** The float switch circuit can be used with a manual switch to turn the pump on and off from a distance. Use any simple on/off switch available from an electronic supply, electrical supply, or hardware store (it only carries 12 volts, very low current). Wire it according to the illustration above, for a normally closed float switch.



## 5.11 Battery-Based Systems

**PS-XXX pump systems can be operated from batteries.**

Install a jumper wire between terminals 6 and 7 to set the controller to battery mode.

This will de-activate the MPP-Tracking function and activate the Low Voltage Disconnect.

**Overload protection** Install a fuse or circuit breaker near the power source. For either 24 or 48V, use a 25 amp circuit breaker (PS200 or PS600 Systems) or a time-delay (slow blow) fuse. The purpose of this protection is for safety in case of a wiring fault, and to provide a means of disconnect when installing or maintaining the system. PS-XXX controllers have electronic over-current protection against motor overload.

**Wire Sizing for the DC circuit** Wire must be sized for no more than 5% voltage drop at 20 amps (starting).

Refer to a wire sizing chart specifically for 24V or 48V, or follow these examples:

24V SYSTEM:

#10 wire to maximum distance of 30 ft.

Metric: 6 sq. mm to max. 10m

48V SYSTEM:

#12 wire to maximum distance of 22 ft.

Metric: 4 sq. mm to max. 13m

**GREATER LENGTHS** For each 150% increase, use next larger wire size.

**ON/OFF switching** You can switch either the primary power to the controller, or the remote (float switch) control circuit. For an explanation, see Section 5.12 (Pressurizing Systems) "Pressure switch connection".

**Low-voltage disconnect function.** Lead-acid batteries can be permanently damaged by over-discharge when the voltage falls below a critical point. To prevent this, the PS battery-system controller will turn off at low voltage, and turn back on only after the battery has recovered significantly. The set points are:

24V SYSTEM: OFF at 22V ON at 24V

48V SYSTEM: OFF at 44V ON at 48V

A controller in disconnect mode can be reset manually by turning off/on, but it will quickly disconnect again if the battery is not gaining a substantial recharge.



**CAUTION** The PS-XXX controller is NOT a battery charge controller. A charge controller prevents battery overcharge. It is a normal part of any renewable energy battery charging system. Be sure the charge controller is appropriate to the type of batteries used. (Sealed batteries use lower voltage settings than liquid-filled batteries.)

## 5.12 Pressurizing Systems

*LORENTZ PS-XXX Pump Systems* are excellent for automatic water pressurizing when powered by a battery system. If you are raising water vertically AND pressurizing, the pump must handle to total head. Note the relationship: 2.31 ft. = 1 PSI (1 Bar = 10 vertical meters.) Example: A pump that lifts 100 vertical feet (30m) and pressurizes to 60 PSI (4 bar) must pump the equivalent of 240 feet (70m). Be sure your *pump* was chosen correctly for your application. The installation is similar to that of a conventional AC pump.

A typical pressurizing control assembly is illustrated in the following photo. These are standard components, same as used for conventional AC water pressure systems. The parts (from left to right) are:

1. check valve (prevents back-flow)
2. pressure gauge 0-100 PSI (0-7 bar)
3. pressure relief valve 75 PSI (5.3 bar)
4. tank tee (a bronze casting that holds all the components)
5. pressure switch (turns the pump on/off according to pressure set-points, adjustable)
6. hose outlet (to drain the system or to supply water when outlet is shut off)
7. ball valve (to shut off the supply to the outlets)

The components can be purchased from local suppliers, or as a kit from your pump supplier

**Pressure tank** A pressure tank is required. We recommend a captive-air pressure tank of 40 GALLONS (150 liters) OR MORE, to assure a steady supply of water pressure as the pump cycles on and off and the water demand varies. A large tank is always best. Size and cost are the only practical limitations. More than one tank can be used to increase the total capacity.

### How to pre-charge a captive-air pressure tank for PS-XXX Pump Systems

For the system to function properly, the air bladder in the tank must be pre-charged with air according to these instructions.

1. Make note of the cut-in setting of the pressure switch (either by observation or knowing the factory setting).
2. Turn off the pump and exhaust the water from the tank if necessary, so the water pressure is 0.
3. Find the air fitting on top of the tank. Measure the air pressure in the tank using a tire gauge.
4. Adjust the pressure to about 3 PSI (.2 bar) LESS THAN THE CUT-IN PRESSURE.

**Pressure switch** PS-XXX Pumps Systems can use an ordinary pressure switch sold for conventional AC pumps. **Do not use a pressure switch with "low water cutout" or "loss of prime" feature** (with a shutoff lever



**WARNING A PRESSURE RELIEF VALVE IS REQUIRED. If the pressure switch fails, this will prevent extreme pressure from bursting the tank or piping and causing a flood. Install the valve near the pressure tank, before the shutoff valve. Use a 1/2" (or larger) valve set about 25-75% higher than the cut-out pressure. Run a pipe or hose from its outlet to a drain or to the outdoors where water discharge will not cause damage.**

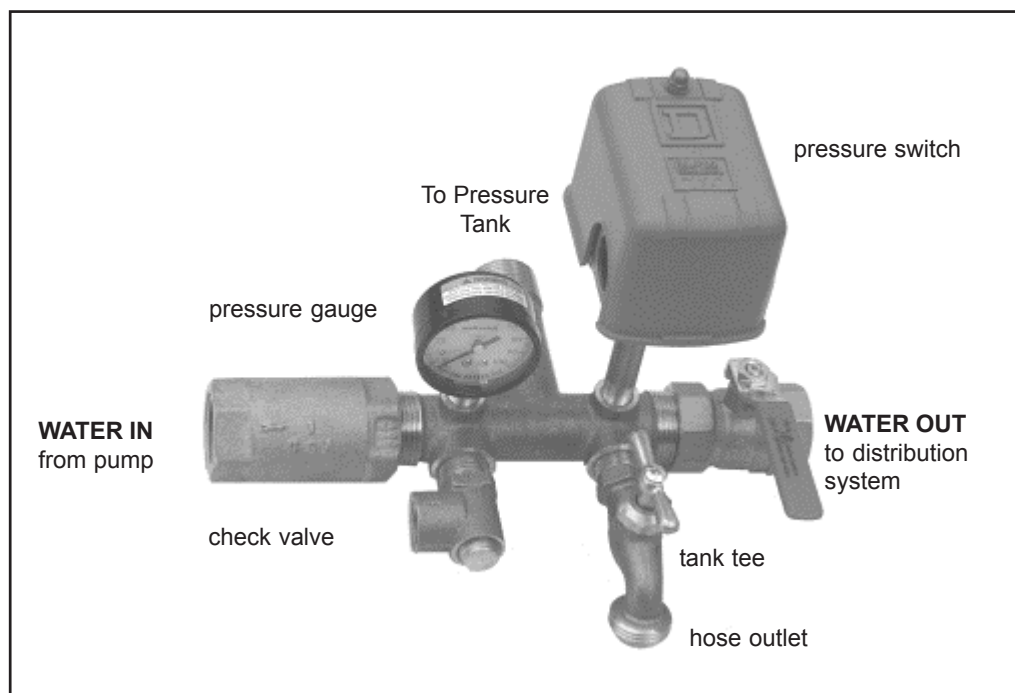

*Pressurizing Systems continued*

on the side). It is intended to prevent dry run of centrifugal pumps. The helical rotor pump types will maintain pressure even as it runs dry, so this device will not work reliably. It will also shutoff if the pressure falls due to high water demand.

**Pressure switch connection** There are two ways to connect the pressure switch:

**1. primary power switching** The switch is used to disconnect the DC power source. Wire the switch between the power source distribution point and the controller, as you would with a conventional pump.

**2. remote switching** This method uses the "remote float switch" terminals. Small wire

(minimum #18 AWG) can be run to the pressure switch from a long distance. See illustration below. *Advantage: the controller stays on all the time. If the water source runs low (even if it recovers) the "Source Low" indicator light will stay on to notify the user. Power draw of the controller in OFF mode is only about 1 watt.*



*Pressure switch connected to the controller (junction box) for "remote switching"*

## 6 PREPARING TO INSTALL THE PUMP

### 6.1 WARNINGS about Handling Helical Rotor Pumps



**WARNING** (helical rotor models) **DO NOT APPLY MACHINE GREASE TO THE PUMP.**

**Ordinary machine grease will damage the stator (NBR**

**rubber) and void the warranty.** Helical rotor pumps are lubricated at the factory with a clear, non-toxic grease. Its only purpose is temporary, to allow the pump to be run dry for a short time to test the direction of rotation. There is no normal reason to reapply lubricant but if you do, use *VASELINE* (petroleum jelly, white petrolatum) or non-toxic silicone grease approved for water valves and seals.



**CAUTION** (helical rotor models) **BEFORE INSTALLATION, KEEP THE PUMP OUT OF THE SUN.** If the pump gets hot, the rubber stator will expand and

may lock the rotor. No damage will result from this, but you may be unable to test the direction of rotation. If the pump gets hot, allow it to cool in water for 20 minutes before testing.



**WARNING for SIPHON APPLICATIONS** If a pump system has a vertical lift **LESS THAN 33 FEET (10m)** up from the surface of the water source, and then the water flows downhill to a lower

point, a siphon effect may cause suction on the pump. This will cause an upward thrust on the motor shaft, resulting in damage to the motor. Prevent this by installing an air vent or a vacuum breaker at the high point on the pipe.

## 6.2 Drop Pipe

**PS-XXX Pump Systems can be installed using the same pipe components that are used for conventional submersible pumps.** Use pipe with a sufficient pressure rating, with coupling components that are designed to handle the weight of the entire assembly.

**Torque arrestor** It is NOT REQUIRED. (soft-start motor system.)

**Size of pipe** A long line of undersized pipe will reduce the performance of the system. Proper selection of pipe size is based on the maximum flow rate and the total length of pipe from the pump to the pipe outlet or tank. Refer to the pump specifications at the end of this manual to determine the peak flow rate for the system you are installing. For sizing of a long pipe line, refer to Section 13.2 Water Pipe Sizing Chart. It is often wise to make buried pipelines extra-large, in case a larger pump is desired in the future.

Reduced drop pipe size should be considered in the following situations:

1. Sandy water conditions – especially with a solar-direct system. The flow will be very slow on cloudy days. This may cause sediment to accumulate in the drop pipe. Smaller pipe will increase the flow velocity and helps exhaust the sediment. (See Section 6.6 “Coping with Dirty Water Conditions”.)
2. Hand installation – to reduce the weight, especially for removal when the pipe is filled with water.

Balance these advantages against the increased friction loss in smaller pipe. You can use a pipe size that is smaller than the pump outlet by using a reducer bushing. Horizontal pipes can be larger.

*PS-XXX Pump Systems* have a stainless steel outlet fitting. It is compatible with iron, steel, galvanized, bronze, brass, or any plastic pipe components.



**CAUTION** Do not assemble iron, steel, or galvanized pipe components in metallic contact with brass or copper. This will cause rapid electro-chemical corrosion.



**CAUTION** If polyethylene (black flexible) pipe is to be used, see Section 7.3.



**CAUTION** Screwing a metal pipe component into a plastic reducer bushing may cause the bushing to crack, sooner or later. If you use a plastic reducer bushing, reinforce it with a hose clamp (all-stainless steel) as shown in the photo. Tighten the clamp first, then hand-tighten the metal pipe component.



**WARNING** Do not use a rope winch to install or remove a pump in a drilled well casing. Do not use a vehicle to install or remove a pump. See Section 7.3.



*Hose clamp reinforcing a plastic reducer bushing*



## 6.2 Safety Rope and Binding

**Safety rope** can prevent loss of the pump. If the drop pipe breaks, the rope will prevent strain on the electrical cable and can be used to pull the pump out. Use 1/4" (6mm) water well safety rope. It can be purchased from *your pump* supplier or from a local pump supplier. Polypropylene marine rope is also good. DO NOT use nylon.

### Secure the safety rope at the wellhead

Prepare to tie the rope inside the well casing. If your well cap does not have a place to tie the rope, drill a hole in the casing and install an eye-bolt. Prepare this detail BEFORE you install the pump. (See Section 13.3 Wellhead Assembly for Drilled Wells.)

### Bind the drop pipe/cable/wires/rope with tape

Lay out the pipe, submersible cable, probe wires and rope on the ground. Do not twist them together. Bind everything to the pipe about every 10 feet (3-4m) using vinyl tape. Use either standard (UL-listed) electrical tape (about 6 to 8 turns) or "pipe wrap tape", which is wider and requires fewer turns. Pipe wrap tape is available from plumbing and electric supply stores. Remember that the pipe will stretch, and the cable will not. Leave a slight excess length of cable between each wrap as illustrated.



**WARNING Do not use nylon cable ties in water.** Nylon absorbs water and gets weak after a few years. To bind the pump cable to the drop pipe, use vinyl electrical tape or pipe-wrap tape.



**WARNING when using flexible POLYETHYLENE (PE) pipe, allow for pipe stretch.** Make the cable, probe wires and rope longer than the pipe, to prevent tension when the pipe stretches.

>> cable & wires – 1.5% longer than pipe

>> rope – 1 % longer than pipe

Distribute the excess length along the length of the pipe (as illustrated) and leave a little more excess length around the splice.

If the water is highly mineralized or has high biological activity, you may choose to hang the low-water probe separately from the pipe, cable and rope, so it can be pulled up separately for inspection or service. See Section 5.9 Low Water Probe.

*Bind the submersible cable, low-water probe wires and safety rope to the pipe.*

*Pipe wrap tape or electrical tape located at about every 10 feet (3 m) over the length of the pipe*

*submersible cable splice*

*low water probe (not shown)*

*Tie safety rope here*

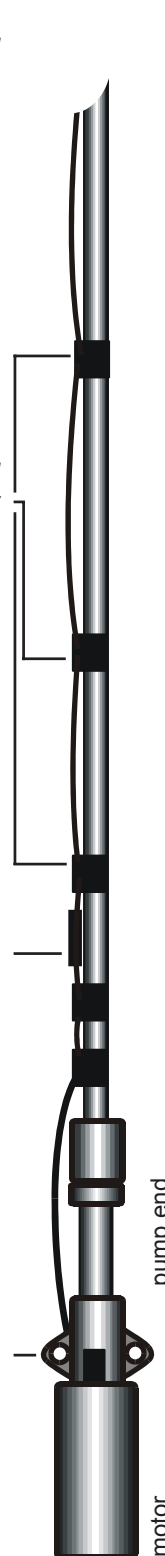

**WARNING Safety rope for well pump installation is for emergency pump removal. It must not be a primary means of support. Make it slightly longer than the drop pipe so it does not bear any weight.**



**WARNING Do not use nylon rope in water.** Nylon absorbs water and weakens after a few years. Failure can cause damage or loss of your equipment. Use polypropylene rope made for water well or marine applications



**WARNING Plastic rope will weaken from long exposure to sunlight.** Secure it *INSIDE* the well casing to avoid exposure. If sun exposure cannot be avoided, use stainless steel wire rope.



## 6.4 Installation in a Surface Water Source

This refers to a surface well, spring, pond, lake, river or tank.

**Positioning the pump** The pump may be placed in an inclined or horizontal position if desired. To reduce the intake of sediment, do not place the intake very close to the bottom.

Models 03, 03H, 04 and 04H have a small "vent hole" near the top of the pump (photo). If the hole is not submersed, it will suck air and prevent the pump from performing fully. The purpose of this hole is to allow water to fill an internal gap, to conduct heat away from the rubber stator.

**River or stream** Secure the pump from logs and debris that may float downstream. Use stainless steel wire rope or chain instead of plastic safety rope (plastic rope will weaken in sunlight). Consider digging a shallow well near the stream. This will allow filtration of the water through the earth, and will protect the pump from floating debris or human tampering.

**Position of the low-water probe** **CAUTION** The low-water probe must be positioned vertically, within 10°. Normally, it is to be installed on the pipe above the pump outlet, as shown in Section 5.9. This will only work if the pump is installed vertically. If the pump is not vertical, find an alternative way to mount or suspend the probe, so that it is higher than the pump, and in a vertical position.

**Is a flow sleeve required?** NO, not within the normal temperature range. The *PS-Pumps* high-efficiency motor generates very little heat. A conventional submersible pump requires a flow sleeve to assist motor cooling when installed in open water (not confined by a narrow casing). It is a piece of 4-6" pipe that surrounds the pump to increase flow around the motor.

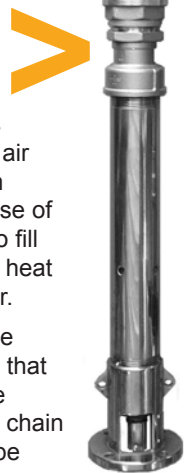

**Depth of submersion** *PS-Pumps* may be submersed as deep as necessary to ensure reliable water supply. The lift load on the pump is determined by the vertical head of water starting at the SURFACE of the water in the source. Increasing the submergence of the pump (placing it lower in the source) will NOT cause it to work harder or to pump less water. Avoid placing the pump close to the bottom where it will pick up sediment.

**Filtration at the pump intake** *PS-Pumps* will tolerate small amounts of sand, but you may need to filter out larger debris that is normally found in a pond or stream. You can construct a simple coarse screen to protect the pump and to reduce the nuisance of debris in your water system. One method is to wrap the pump with about 6-8 layers of loosely-woven fabric or screen, of a material that will not decay or rust. Some suggestions are fiberglass window screen, agricultural shade cloth, or weed-barrier fabric (available from nursery and landscaping suppliers). Bind the fabric or screen with all-stainless hose clamps, rubber, or polypropylene rope. Do not use nylon; it softens with submersion in water. An improved method is to construct a sealed pump enclosure from 4-6" plastic pipe, with many holes or slots to let water in. Then, wrap the screen around that enclosure. This will distribute the flow through a much larger area of screen. After cutting holes or slots in the plastic pipe, wipe the inside carefully to remove plastic shavings and dust.



**WARNING for SIPHON APPLI-**

**CATIONS** If a pump system has a vertical lift of less than 33 feet up from the surface of the water source, and then the water flows downhill to a lower point, a

siphon effect may cause suction at the pump outlet. This will cause an upward thrust on the motor shaft, resulting in damage to the motor. Prevent this by installing an air vent or a vacuum breaker at the high point on the pipe.



**CAUTION** The pump must be fully submersed. A helical rotor pump may overheat and stop (temporarily) if the pump end is not fully submersed.



**CAUTION** High water temperature can cause failure to start. Low temperature can reduce lift and flow capacity. This can occur in surface water during weather extremes, due to temporary expansion or contraction of the rubber stator. The product specifications say: Optimum water temp. is 46°F to 72°F (8°C to 22°C). Other ranges are available by special order. These performance problems are temporary and will NOT damage the pump. If you are uncertain about using the pump you received, contact your supplier before you install it.

## 6.5 Deep Well Setting — How Deep?

*PS-Pumps* may be submersed as deep as necessary to ensure reliable water supply. The lift load on the pump is determined by the vertical head of water starting at the SURFACE of the water in the source. Increasing the submergence of the pump (placing it lower in the well) will NOT cause it to work harder or to pump less water, nor will it increase the stress or wear on the pump.

There are reasons NOT to set the pump near the bottom of the well, if it isn't necessary:

1. A deep setting will increase the size requirements, costs and weight of pipe and cable.
2. A deep setting may increase the chance of sand or sediment being drawn into the pump.

To make an informed decision, it is helpful to have accurate data for your water source. In most places, drillers are required to report the details and the performance of wells that they drill. If you do not have the driller's well record, you may be able to obtain a copy from your regional government office that oversees ground water resources and issues drilling permits. In USA, it is a state office, typically called Department of Natural Resources or State Engineer's Office. However, the data may be missing or inaccurate, and conditions can change over the years. In critical cases, it is wise to have the well re-tested by a water well contractor.

## 6.6 Coping with Dirty Water Conditions

*PS-Pumps* have good resistance to quantities of sand and fine sediment that can normally occur in a well. However, any amount of abrasive material will reduce the life of this pump, like any other pump. Extreme sediment can cause the pump to stick. Sediment can also settle inside the drop pipe each time the pump stops, and block the flow. For water sources that contain high amounts of sand, clay, or other solids, consider the following suggestions.

To avoid pumping dirty water

1. Have your well purged, developed, or otherwise improved by a water well contractor before installing the pump.
2. Temporarily install a more powerful pump to draw at a high flow rate until the water looks clean.
3. Set the pump as high as possible in the well. If the pump can be placed higher than the perforations in the well casing, it will probably avoid all but the finest suspended silt.
4. After lowering the pump in a well, wait at least 15 minutes for sediment or debris to settle down.
5. If the water source is at the surface, dig a shallow well next to the water source to obtain clean water.
6. If the water source is at the surface, use a fabric screen to protect the pump (see Section 6.4).

If dirty water cannot be avoided

1. Use a reduced size of drop pipe. This will maximize the velocity of water flow in order to exhaust sand particles. Refer to Section 13.2 Water Pipe Sizing Chart. Select the smallest size pipe that does not impose excessive friction loss. Use a reducer bushing on the pump if necessary, to adapt it to a smaller pipe size (see the caution about plastic bushings in Section 6.2).
2. Monitor the situation regularly by observing the volume of water pumped and/or the current draw of the pump (AC amps – see Section 9.3 and 13.7). As a pump wears, its flow rate (and current draw) will decrease gradually. Replace the pump end when reduced performance is observed, or before your season of greatest water demand. Increased current draw may indicate debris stuck in the pump and/or pipe.

## Q+A

**Question** *What effect does hard, mineralized, alkaline or salty water have?*

**Answer** *Generally, none. Dissolved minerals and salts are not abrasive.*

## 6.7 Utilizing a Low-Production Water Source

*PS-Pumps* can make the best of a limited water source, even if the pumping rate can exceed the recovery rate. You want to draw the most water possible, without running dry. *PS-Pumps* can handle this in two ways.

**The low-water probe** The low-water probe allows the pump to work to its full potential until the water level drops (see Section 5.9). This is a good strategy because you get all the water you can while the sun shines. Place the pump near the bottom of the well to utilize the storage of water in the well. When the pump is stopped by the low-water probe, it re-starts after a 20 minute delay. The Low Water OFF light will slowly flash even after the water recovers and the pump restarts, to indicate that the level got low at some time during the day. See Section 5.9, Low Water Probe. It may be feasible to hang the probe independently and use it to locate the water level at any moment. See Section 6.3, Safety Rope and Binding.

**Reduce the Maximum RPM setting** If the well has little storage capacity, the supply may recover before the 20-minute restart delay. In this case, reduce the “Maximum RPM” setting in the controller. See Section 5.6.



**WARNING Do not use a valve as a means of reducing the flow.** With a helical rotor pump, excessive pressure may result. Use the Maximum RPM setting instead.

## Q+A

**Question** How is a pump damaged from “dry run”?

**Answer** If the pump runs completely dry, parts will overheat and be damaged. However, if water is only trickling into the pump, it will usually provide enough lubrication and cooling to prevent damage.

## 6.8 Installing the Pump Under a Windmill or Hand Pump Cylinder

*PS-Pumps* can be combined with a classic water-pumping windmill or hand pump, to utilize both energy sources automatically. The following system is often used with a conventional AC pump, so a generator can be used for backup. The AC pump is placed immediately below the cylinder, and connected to the cylinder’s threaded intake. When power is applied to the AC pump, it pushes water up through the cylinder, pushing its valves open. When the windmill draws water, it sucks it up through the AC pump with little resistance. (The centrifugal pump end of the standard AC pump allows water to flow through it when it is stopped.) When both pumps operate, each one is relieved of its load, more or less.

This system can be employed with *PS-Pumps*. A centrifugal model (one with a “C” in the model number) will allow water to flow freely through it and does NOT require any special precautions. For helical rotor models, the following warning applies.

To use a helical rotor *pump* under a cylinder, you must build a bypass assembly with a T fitting and a foot valve (a check valve with intake screen). When the cylinder’s flow exceeds that of the solar pump, water is sucked in through the foot valve. When the solar pump’s flow exceeds that of the cylinder, the foot valve closes and allows the solar pump to work normally and push up through the cylinder.

To make this system for a casing 6" (150 mm) or smaller, an offset using 45° elbows must be carefully constructed, as illustrated. Copper fittings must be used for the bypass assembly due to the limited space in the well casing. Do not use any iron fittings in this assembly.



**WARNING helical rotor models (those without a “C” in the model number) will NOT allow water to flow freely when stopped. A bypass foot valve must be used. If it is not used, the resulting suction can cause an uplift on the rotor which will cause damage and void the warranty.**

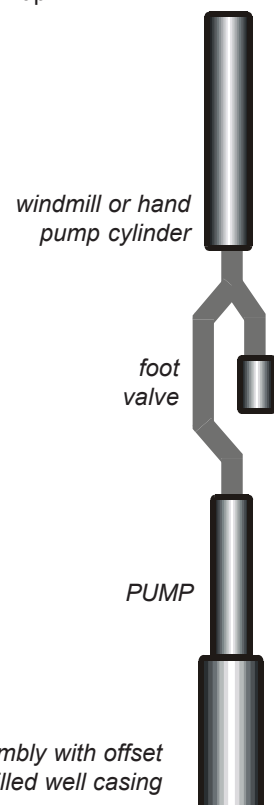

*Bypass foot valve assembly with offset elbows to fit a drilled well casing*

## 7 IN-WELL ASSEMBLY AND INSTALLATION

**SEE REFERENCE SECTION** At the end of this manual (Section 13) you will find instructions for wellhead assembly, water storage, control and monitoring of water supply, pipe sizing, freeze protection, and more.

### 7.1 Rubber Spacers (Models -07, -10, -14, -20 only)

This applies **ONLY** to models HR-07, 10, 14 and 20 (HR-07, 14 and 20 pump ends)

Helical rotor pumps vibrate due to the eccentric rotation of the helical rotor. This is normal. Rubber spacers reduce the vibration that may be transferred to the well casing. Models -03 and -04 vibrate very slightly so they are not supplied with rubber spacers.



These helical rotor models do NOT have rubber spacers:

- HR-03
- HR-04
- HR-04H

These models have rubber spacers:

- (HR-07)
- (HR-10)
- (HR-14)
- (HR-20)



**CAUTION** The threads in the check valve require an adhesive sealant. They are not tapered pipe thread. Normally, there is no reason to remove the check valve. If you do remove it, use a hardening adhesive sealant or epoxy glue when you replace it. See CAUTION in Section 9.1.

**Clearance for drilled well casings** Rubber spacers fit a 6" (150 mm) inside-diameter or larger well casing.

**Cut the rubber spacer legs to fit smaller casing** If you are installing the pump in a well casing smaller than 6", cut the spacer legs. Grooves indicate where to cut for a 4" (100 mm) casing. Use a fine-tooth saw to cut the rubber.

## 7.2 Machine Installation

If you are professionally equipped to install conventional AC submersible pumps, you can use the same equipment and methods for our pumps. *PS-Pumps* have no special pipe requirements. You can use any suitable rigid or flexible pipe. The only exception is to consider reducing the pipe size in cases of high sand concentration (to increase flow velocity). See Section 6.2 Drop Pipe, and Section 13.2 Water Pipe Sizing Chart.

## 7.3 Hand Installation

Water well pumps can be installed by hand in shallow water sources and in remote areas that are not accessible to a pump service truck. Hand installation is generally performed using rolled flexible POLYETHYLENE (PE) drop pipe rather than rigid pipe. In North America, most professional pump contractors do NOT have the equipment to pull flexible pipe. Their equipment is designed for rigid pipe in 21-foot pieces. Do not use flexible pipe unless you are committed to safely handling its total weight (full of water) IN THE FUTURE when the pump must be removed. For installations that are deeper than about 50 feet (15m), please consider the following warnings and cautions.

We do not encourage hand installation except in shallow-water situations. Installation and removal should never be performed by hand without an adequate number of workers. If you have any doubts about the feasibility, safety and economy of installation AND future removal, hire a professional pump service contractor.

Before considering installation or removal by hand, estimate the weight of the system and consider the number of people necessary to install the pump AND to remove it in the future (with water in the pipe). To estimate the total weight, add the following:

1. Cable weight — #10 submersible cable (3-wire + ground) weighs approximately 25 lbs. per 100 ft. (40 kg per 100m). Each larger size (smaller AWG#) weighs approximately 30% more.
2. Water in the pipe (lbs.) = pipe inside diameter (inches)<sup>2</sup> X 0.34 X length (feet).  
Example: Water in 100 feet of 1" pipe weighs about 34 lbs.
3. The pump weighs approximately 25 lbs. (11.5 kg.).



**WARNING** Hand installation and removal is potentially hazardous.

**WARNING DO NOT USE A VEHICLE** to install or remove a pump. During removal, the pump can catch on joints or edges in the well casing. Damage or loss of the pump can occur before the vehicle operator can react.

**WARNING DO NOT USE A ROPE WINCH** to install or remove a pump in a drilled well casing (borehole).

*If you use a winch to pull the pump by pulling the safety rope, the electrical cable can slip down the pipe and/or the pipe can collapse. If the pipe or cable jams and gets wedged in the casing, you can lose your equipment and even permanently block the well! Some installers use a winch with a reel of about 3 feet (1m) diameter or larger, to pull flexible pipe. This is ideal if you have the equipment and experience to do the job safely.*



### CAUTIONS for polyethylene pipe (PE, rolled pipe)

1. Do not exceed the pressure rating of the pipe. The most common PE pipe is type SDR-15. It has a pressure rating of 100 PSI (7 bar). This is equal to 230 feet (70m) of total vertical lift. Types SDR-9 and SDR-7 have a pressure rating of 200 PSI (14 bar), equal to 460 feet (140m). They are available from local suppliers in some areas, or from your Solar pump supplier. Special compression connectors are made for this pipe.
2. Use only pipe connectors that are designed for the pipe you choose. Do not use galvanized steel adapters. They will rust through.
3. Do not use any sealing compound in PE pipe connections.
4. If you use insert connectors with hose clamps, use TWO clamps at each adapter. Tighten them with a wrench. Use "all stainless" hose clamps. Automotive clamps have carbon steel screws that will rust and fail.
5. Have extra hose clamps on hand in case you damage or lose one.
6. Have an extra coupling on hand in case you bend the pipe too sharply (kink it) and make a weak spot.
7. PE pipe will stretch about 1%. Make the electrical cable and safety rope about 1.5% longer than the pipe so when the pipe stretches, the cable and splice will not be stressed.
8. If you plan to bury PE pipe in the ground, contact the pipe manufacturer for additional instructions.



## 7.4 Sanitizing the Well

Sanitizing a well will kill bacteria that may have been introduced during the pump installation. This can be done with chlorine bleach or chlorine pellets poured down the well just before or just after a pump is installed. Once you introduce these chemicals make sure that the pump is working to prevent that it sits for a longer time in the aggressive environment.



Consult a local supplier or environmental health authority for a recommended procedure. Do not use an excessive concentration.

**WARNING *PS-Pumps* may be damaged by soaking in a high concentration of chlorine solution. Avoid prolonged contact.**

## 8 OPERATING THE PUMP

This explains the function of the switch and the indicator lights on the pump controller.

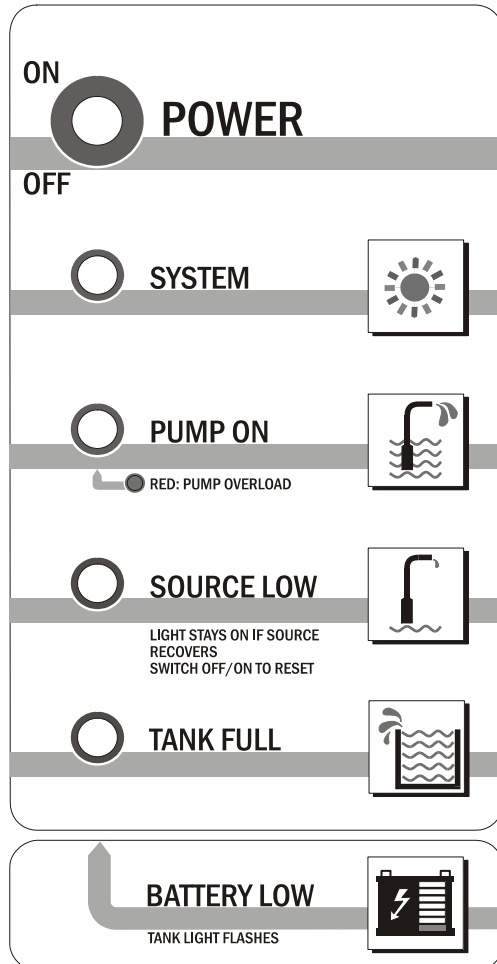

### SWITCH

#### POWER ON/OFF

When switched off/on during operation, it resets all system logic.

#### Indicator lights

#### SYSTEM (green)

The controller is switched on and the power source is present. In low-power conditions, the light may show even if there is not enough power to run the pump.

#### PUMP ON (green)

Motor is turning. Sequence of flashing indicates pump speed. See below sequence

#### PUMP OVERLOAD (green changes to red)

#### SOURCE LOW (red)

The water source dropped below the level of the low-water probe. After the water level recovers, the pump will restart, but this light will slowly flash until the sun goes down, power is interrupted, or the POWER switch is reset. This indicates that the water source ran low at least once since the previous off/on cycle.

#### TANK FULL (red)

Pump is turned off by action of the remote float switch (or pressure switch or manual switch, whichever is wired to the "remote float switch" terminals.

#### BATTERY LOW (tank light flashes)

**Battery systems only** – battery voltage fell to 44 / 22V, and has not yet recovered to 48/24V.

**RPM indication:** Pump speed can be read off by the flashing sequence of the Pump ON LED.

LED ON	> 900
One flash	> 1200
Two flash	> 1600
Three flash	> 2000
Four flash	> 2400
Five flash	> 2800

## Operating the Pump continued

**Starting the pump** Be sure there is not a closed valve or other obstruction in the water line. Switch on the array disconnect switch in the junction box, and toggle the power switch on the controller. It is normal to leave the switches on at all times, unless you desire to have the system off.

A solar-direct pump should start under the following conditions

1. clear sunshine at an angle of about 20° or more from the surface of the solar array
2. cloudy conditions, if the sunshine is bright enough to cast some shadow
3. low-water probe submersed in the water source (or bypassed in the controller) – Water-Low light OFF
4. full-tank float switch is not responding to a full tank – Tank-Full light OFF
5. battery system only – voltage is higher than the low-voltage disconnect point (22V or 44V)

**When sunshine is insufficient** When sunshine on the array is present, but too weak for the pump to run, it will attempt to start about every 90 seconds. During each attempt, you will see the PUMP ON light come on.

When pump runs slowly (PUMP ON) under weak sun conditions

1. *PS-Pump* models that have “C” in the model number — These use a centrifugal pump end. In weak sun, the pump may spin without lifting water all the way to the outlet. This is normal.
2. *PS-Pump* models that do NOT have “C” in the model number – These use a helical rotor (positive displacement) pump end. If the pump is turning, even slowly, water will be delivered at a slow rate.

When pump stops from a sudden shadow on the solar array

If a shadow suddenly passes over the array, like if you walk in front of it, the controller will lose track of the input voltage. It may make rapid on/off noises and a high-pitched noise, then stop. This does NOT indicate a problem. The pump will attempt to restart after the normal delay.

## Time delays

1. After pump stops due to insufficient sunshine – 120 SECONDS
2. After full-tank float switch resets – 2 to 3 SECONDS
3. After low-water probe regains contact with water in the source — 20 MINUTES but the indicator light will slowly flash for the rest of the solar day, or until power is disrupted or the controller is turned off/on.
4. Battery systems – after low voltage disconnect point is reached, delay to stop pump – a few SECONDS. After voltage recovers, delay to re-connect – a few SECONDS

**To force a quick start** To test or observe the system, you can bypass the normal time delays. Switch the POWER switch off then on again. The pump should start immediately if sufficient power is present.

**Pump vibration** Most *PS-Pump* models use a HELICAL ROTOR pump end (those that do NOT have a “C” in the model number. A slight vibration is normal with these pumps. If noise is disturbing, try changing the position of the pump. *PS-Pump* models that have a “C” in the model number use a CENTRIFUGAL pump end similar to conventional pumps. They should produce no significant vibration.

**PUMP OVERLOAD (PUMP ON light shows red instead of green)** The system has shut off due to an overload. This can happen if the motor or pump is blocked or very difficult to turn and is drawing excessive current (hard to turn). Overload detection requires at least 250 Watt output of the solar array. This can be caused by a high concentration of solids in the pump, high water temperature, excessive pressure due to high lift or a restriction in the pipe, or a combination of these factors. The controller will make 3 start attempts before shutting down the system. The System ON LED will be OFF and the red OVERLOAD LED ON. The system will not reset until the ON / OFF switch is turned OFF and ON again. See Troubleshooting, Section 9.3 “HIGHER CURRENT”.



## 9 TROUBLE SHOOTING

**Please read this section before calling for help.**

If you call for help, please refer to the model and serial numbers. (See SYSTEM REPORT, page 3.)

**IF THE CONTROLLER MUST BE REMOVED FOR REPAIR OR REPLACEMENT** Remove the wires and flexible conduit from the controller and remove the CONTROLLER ONLY.

**LEAVE THE JUNCTION BOX IN PLACE.**

### 9.1 If The Pump Doesn't Run

Most problems are caused by wrong connections (in a new installation) or failed connections, especially where a wire is not secure and falls out of a terminal. The *System ON* light will indicate that system is switched on and connected to the controller. It indicates that VOLTAGE is present but (in a solar-direct system) there may not be sufficient power to start the pump. It should attempt to start at intervals of 120 seconds.

**Pump attempts to start every 120 seconds but doesn't run**

The controller makes a slight noise as it tries to start the pump. The pump will start to turn or just vibrate a little.

1. There may be insufficient power reaching the controller. A solar-direct (non-battery) system should start if there is enough sun to cast a slight shadow. A battery system should start if the supply voltage is greater than 22V (24V system) or 44V (48V system).
2. If the pump was recently connected (or reconnected) to the controller, it may be running in reverse direction due to wiring error. See Section 5.8.
3. If the motor shaft only vibrates and will not turn, it may be getting power on only two of the three motor wires. This will happen if there is a broken connection or if you accidentally exchanged one of the power wires with the ground wire. See Section 9.3, testing the motor circuit and the controller output.
4. The pump or pipe may be packed with mud, clay, sand or debris.
5. Helical rotor models: The rubber stator may be expanded from heat, due to sun exposure or pumping water that is warmer than 72°F (22°C). This may stop the

pump temporarily, but will not cause damage. (See Section 12, Temperature Specifications.)

6. Helical rotor models: The pump may have run dry. Remove the pump stator (outer body) from the motor, to reveal the rotor. If there is some rubber stuck to the rotor, the pump end must be replaced.
7. Helical rotor models: The check valve on the pump may be faulty or stuck, allowing downward leakage when the pump is off. This can prevent the pump from starting.

**PUMP OVERLOAD (PUMP ON light shows red instead of green)** The system has shut off due to an overload. This can happen if the motor or pump is blocked or very difficult to turn and is drawing excessive current (hard to turn). Overload detection requires at least 250 Watt output of the solar array. This can be caused by a high concentration of solids in the pump, high water temperature, excessive pressure due to high lift or a restriction in the pipe, or a combination of these factors. The controller will make 3 start attempts before shutting down the system. The System ON LED will be OFF and the red OVERLOAD LED ON. The system will not reset until the ON / OFF switch is turned OFF and ON again. See Troubleshooting, Section 9.3 "HIGHER CURRENT".



**CAUTION DO NOT REMOVE THE CHECK VALVE from the pump.** *If you want to look for dirt stuck inside the pump, it is preferable to unbolt the pump body and pull it from the pump. IF YOU MUST REMOVE THE CHECK VALVE, use a hardening adhesive sealant on the screw threads when you replace it. Epoxy glue is good. The threads are not tapered. They will leak if a hardening sealant is not used. Teflon tape will make a good seal, but it may not prevent the joint from unscrewing.*

## 9.2 Inspect The System

Many problems can be located by simple inspection. No electrical experience is required for this.

### Inspect the solar array

1. Is it facing the sun? (See solar array orientation, Sections 4.4 and 4.5)
2. Is there a partial shadow on the array? If only 10% of the array is shadowed, it can stop the pump!

### Inspect all wires and connections

1. Look carefully for improper wiring (especially in a new installation).
2. Make a visual inspection of the condition of the wires and connections. Wires are often chewed by animals if they are not enclosed in conduit (pipe).
3. Pull wires with your hands to check for failed connections.

### Inspect the controller and junction box

1. Remove the screws from the bottom plate of the controller. Move the plate downward (or the controller upward) to reveal the terminal block where the wires connect. (See Section 5.5.)
2. First, check for a burnt smell. This will indicate a failure of the electronics. Look for burnt wires, bits of black debris, and any other signs of lightning damage.
3. Open the junction box. Is the Power IN switch turned ON? Pull on the wires to see if any of them have come loose.
4. Inspect the grounding wires and connections! Most controller failures are caused by an induced surge from nearby lightning where the system is NOT effectively grounded. Ground connections must be properly made and free of corrosion. (See Section 5.2.)

### Check the low-water probe system (See Section 5.9)

If the controller indicates "SOURCE LOW" when the pump is in the water, inspect the low-water probe system. The probe is mounted on, or near the pump. If inspection is not feasible, you can bypass the probe or test it electrically. See Section 9.3 below.

1. If the probe is NOT being used, there must be a wire between terminals 1 and 2.
2. The probe is a cylindrical plastic device mounted on or near the pump. It contains a small float on a vertical shaft. The float

must be able to move up to indicate that it is submerged, and down to indicate that it is dry.

3. The probe must be positioned vertically (within about 10°).
4. The probe or a probe wire may be broken. Inspect the wires for damage.
5. Does the pump run when the probe is OUT of the water? This can happen if the float in the probe is stuck. In surface water, this can happen from algae, a snail, or other debris (see Section 5.9).
6. If the pump was purchased before August 2003, it may have a wet-electrode probe. In case of trouble, it can be replaced with a new (mechanical float) probe, with no changes to wiring or controller.

### Check the full-tank float switch (See Section 5.10)

If the controller indicates "TANK FULL" when the storage tank is not full, inspect the float switch system. If your system has a float switch, it will be mounted in the tank. If inspection is not feasible, you can bypass the switch or test it electrically. See Section 9.3 below.

1. If a float switch is NOT being used, there must be a wire between terminals 4 and 5.
2. Inspect the float switch. Is it stuck in the UP position?
3. There are two types of float switch, normally-open and normally-closed. Check to see that the wiring is correct for the type that is used. (See Section 5.10)

### Force a quick start

If you restore a connection or bypass the probe or float switch, there is no need to wait for the normal time delay. Switch the on/off switch (or the power source) off then on again. The pump should start immediately if sufficient power is present.

### 9.3 Electrical Testing

A “multimeter” is required and a clamp-on ammeter is helpful. For advice, see Section 13.7, Selecting and Using Meters for Electrical Testing.

**Record your test results on the Problem Report Form, Section 9.5.**

**“Test #” REFERS TO TABLES AND PHOTOS IN SECTION 9.6**

**If you see a false reading of the SOURCE LOW or TANK FULL light, go to Test # 9 / 10 / 11**

#### Test the solar array circuit

1. OPEN-CIRCUIT VOLTAGE Section 9.6 **cf. Test #1** This is “idle” voltage. It is normally high because no current is being drawn (it’s doing no work).
2. SHORT CIRCUIT CURRENT **cf. Test #2** or spark test — This is helpful if the pump is trying to start or does not seem to get full power. DISCONNECT THE ARRAY from the controller before making this test. (A short circuit at the array will only cause current slightly higher than normal.) If you don’t have a DC amp meter, a spark that can jump 1/4" (6 mm) indicates a good probability that the array is working properly.
3. VOLTAGE UNDER LOAD (with pump running) **cf. Test #3**
4. CURRENT UNDER LOAD **cf. Test #4**

Was power was connected to the controller with reverse polarity?

**No lights will show on the controller. This will not cause damage. cf. Test #1**

#### Test the motor circuit (resistance test with POWER OFF), cf. Test #7

Make this test if there is proper voltage at the controller input but the motor does not run. It will confirm the condition of the entire motor circuit, including the motor, pump cable and splice.

#### Test the running current of the motor circuit (AC amps), cf. Test #6/6A

This is one of the most useful trouble shooting techniques because it indicates the force (torque) that the motor is applying to the pump. For greatest ease, use a clamp-on ammeter, available from local electrical equipment suppliers. It allows you to measure current without breaking connections (cf. Test #6A).

**Table of AC RUNNING CURRENT** For helical rotor pumps, normal running current indicated on this table. The current stays nearly constant as voltage and speed vary. Your measurements may vary by as much as 10%, and more if temperature is out of the normal range. Comparing your reading with this table. This will indicate whether the work load on the motor is normal for the lift it is producing. Make note of your measurement. Future changes may indicate pump wear, or change in the level of the water source.

#### HIGHER CURRENT (especially PUMP OVERLOAD light) may indicate:

1. The pump may be handling excessive sediment (sand, clay).

### 9.3.1 Table of AC running current for PS200 and PS600 systems

Pump	Lift	8 25	15 50	23 75	30 100	38 125	46 150	53 175	61 200	76 250	91 300	107 305	122 400	137 450	152 500	167 550	180 600	195 650	210 700	m ft	
HR03H		2.0	2.2	2.3	2.4	2.5	2.7	2.9	3.0	3.3	3.9	4.1	4.3	4.5	4.8	5.0	5.2	5.6	5.8	AC Amps	
HR04H		2.0	2.2	2.5	2.7	2.9	3.1	3.3	3.6	4.0	4.4	4.9	5.3	5.8	6.2	6.9					
HR04		1.4	1.6	1.9	2.1	2.4	2.6	2.9	3.1	3.6	4.1	4.7									
HR07		2.3	2.7	3.1	3.4	3.8	4.2	4.5	5.0	5.7	6.4	7.2	7.9	8.7							
HR14		2.7	3.7	4.5	5.3	6.3	7.1	7.9	9.0												
HR20		3.7	4.8	6.1	7.3	8.5															

### 9.3.2 Table of AC running current for PS1200 systems

Pump	Lift	5 16	10 33	15 49	20 65	30 100	40 133	50 166	60 200	70 233	80 266	90 300	100 330	120 400	140 466	160 533	180 595	200 650	230 750	m ft
HR03H		1.0	1.0	1.1	1.2	1.3	1.4	1.4	1.5	1.7	1.8	1.9	2.0	2.2	2.4	2.6	2.8	3.0	3.4	AC Amps
HR03		0.9	1.0	1.0	1.1	1.1	1.2	1.3	1.5	1.5	1.6	1.7	1.8	2.0	2.2					
HR04H		0.9	1.0	1.1	1.2	1.3	1.4	1.6	1.8	1.9	2.1	2.2	2.3	2.7	3.0					
HR04		0.7	0.7	0.8	0.9	1.1	1.2	1.4	1.6	1.8										
HR07		1.2	1.3	1.4	1.5	1.8	2.1	2.4	2.7	3.0	3.3	3.5	3.9	4.5						
HR10		1.6	1.8	2.0	2.2	2.6	3.0	3.4	3.8	4.1	4.7									
HR14		1.2	1.5	1.9	2.2	2.8	3.4	4.1	4.7	5.4										
HR20		1.6	2.0	2.4	2.8	3.7	4.5													
C-DF-03		4.8	4.8																	
C-BF-04		4.8	4.6	4.3	3.6															

## Electrical Testing continued

2. The total dynamic head (vertical lift plus pipe friction) may be higher than you think it is.
3. There may be an obstruction to the water flow — sediment in the pipe, ice in the pipe, a crushed pipe or a partially closed valve. (Is there a float valve at the tank?)
4. Helical rotor models: Water may be warmer than 72°F (22°C). This causes the rubber stator to expand and tighten against the rotor (temporarily, non-damaging). See Section 12 for temperature limits.
5. Helical rotor models: Pump may have run dry. Remove the pump stator (outer body) from the motor, to reveal the rotor. If there is some rubber stuck to the rotor, the pump end must be replaced.

To reset the OVERLOAD shutoff (red light), switch the pump controller OFF and ON.

### LOWER CURRENT may indicate:

1. In a deep well, the level of water in the source may be far above the pump intake, so the actual lift is less than you think. This is not a problem.
2. The pump head may be worn, thus easier to turn than normal (especially if there is abrasive sediment).
3. There may be a leak in the pipe system, reducing the pressure load.
4. Helical rotor models: Water may be colder than 46°F (8°C). This causes the rubber stator to contract, away from the rotor. The pump spins easier and produces less flow under pressure.

### Test the low-water probe circuit

If the controller indicates “SOURCE LOW” when the pump is in the water, the low-water probe system may be at fault. (See Section 5.9.) The controller applies 5VDC to the probe terminals. When the water level is above the probe, the switch in the probe makes contact. That causes the applied voltage to drop toward zero. The systems “sees water” and allows the pump to run. If the voltage is greater than 3V, dry shutoff is triggered. **Test #9**

The low-water probe has an internal 1KΩ resistor in series with the switch. When closed (in water), the normal resistance is around 1000Ω.

To bypass the low-water probe (and activate the pump), connect a small wire between the probe terminals (**Test #1** and **Test #2**) in the junction box. Restart the controller. If the pump runs, there is a fault at the probe or in the probe wiring. The wires may be shorted (touching each other) or open (broken) or the moving part on the probe may be stuck with debris, or the probe may be out of its normal, vertical position.

### Test the full-tank float switch

If the controller indicates “TANK FULL” when the tank is not full, the float switch or pressure switch system may be at fault. (See Section 5.10 or 5.12)

1. If the remote switch circuit is NOT being used, there must be a wire between terminals 4 and 5.
2. There are two types of float switch, “normally open” and “normally closed”. Check to see that the wiring is correct for the type that is used.
3. Most float switches are “normally open”. Disconnect a wire from terminal 3 or 4, and the pump should run. Connect a wire between terminal 3 and 4, and the pump should stop. See also **Test #10**
4. Most pressure switches (and some float switches) are “normally closed”. Connect a wire between terminals 4 and 5, and the pump should run. See also **Test #11**

If the pump responds to the bypass tests above but not to the float switch, the wires may be shorted (touching each other) or open (broken), or the switch may be stuck

## 9.4 If The Pump Runs But Flow Is Less Than Normal

with debris, or out of its correct position.

1. Is the solar array receiving shadow-free light? (It only takes a small shadow to stop it.) Is it oriented properly toward the south, and tilted at the proper angle? See Section 0.
2. Be sure you have the right pump for the total lift that is required, out of the well + up the hill. In the case of a pressurizing system, the pressure head is equivalent to additional lift (1 PSI = 2.31 feet) (1 bar = 10 m).
3. Be sure all wire and pipe runs are sized adequately for the distance. Refer to wire sizing in the pump sizing table, and to the pipe sizing chart in this manual, reference section.
4. Inspect and test the solar array circuit and the controller output, as above. Write down your measurements.
5. There may be a leak in the pipe from the pump. Open a pipe connection and observe the water level. Look again later to see if it has leaked down. There should be little or no leakage over a period of hours.
6. Measure the pump current and compare it with the table in the previous section.

### Test #6

7. There is a "max. RPM" adjustment in the controller. It may have been set to reduce the flow as low as 50%. See Section 5.6.

### Has the flow decreased over time?

1. Is the AC motor current lower than normal? The pump end (pumping

mechanism) may be worn from too much abrasive particles (sand or clay) in the water.

2. Is the AC motor current higher than normal? Doesn't start easily in low light? This is likely to be related to dirt in the pump and/or pipe.
3. Look in the water tank or pipes to see if sediment has been accumulating.
4. Run the pump in a bucket to observe.
5. Remove the pipe from the pump outlet (check valve) and see if sand or silt is blocking the flow.
6. If the check valve itself is clogged with dirt, see CAUTION, Section 9.1.
7. To help prevent dirt problems, see Section 6.6 Coping With Dirty Water Conditions.
8. After years of use, it may be necessary to replace the pump end. Call your pumps supplier for advice.



### 9.5 Problem Report Form

If you need help, this form will expedite the trouble shooting process. Please fill it in to the best of your knowledge.

Date

#### Contact Info

Dealer

Installer

System Owner

Person responsible for trouble shooting

How to contact

#### Pump System ID

Solar-direct or battery system?  Solar-direct  battery

Pump or System Model #

Pump Model #  Serial #

Controller Model #  Serial #

#### If Battery System

Voltage  v

Is it pressurized?  yes  no

#### Well/Water Source Data

Well depth	<input type="text"/>	Installation Date	<input type="text"/>
Static water level	<input type="text"/>	Drop pipe, length & size	<input type="text"/>
Drawdown level	<input type="text"/>	Pipe from well head to tank, length & size	<input type="text"/>
Recovery rate of well	<input type="text"/>	Pump cable size & length	<input type="text"/>
Depth of pump setting	<input type="text"/>	Wiring from solar array to controller, size & length	<input type="text"/>
Additional vertical lift from top of well	<input type="text"/>		
Total head	<input type="text"/>		

Problem Report Form continued

## Describe the Problem

If pump won't start, include sequence and duration of the indicator lights.

Low-water probe: Is the low-water probe installed?  yes  no  
 If not, there must be a wire between junction box terminals 1 and 2.  
 (See Section 5.9.)

Did you test the pump before installation in the well?  yes  no

Did the system work properly before this problem?  yes  no

Has there been a thunderstorm recently?  yes  no

Has the RPM control in the controller been reduced from maximum?  yes  no

### SOLAR-DIRECT systems only:

There must be NO OTHER electrical load or device connected to the same solar array. This may include an active (electric) solar tracker (LORENTZ active trackers can work together with our pumps) or an electric fence charger. **Disconnect it and try it again.**

## ELECTRICAL MEASUREMENTS

**Test # refers to the photos in Section 9.6**

Weather conditions during measurement

Time of day

Solar array (or battery) volts with PUMP OFF  V DC **Test #1**

Solar array (or battery) volts during pumping  V DC **Test #3**

Solar array (or battery) current during pumping  ADC **Test #4/4A**

Pump Speed, count the number of flashes  **Test #5**

*Problem Report Form continued*

Measure each pair L1-L2, L1-L3, L2-L3. These are the “three phases”.  
**EACH READING MUST BE EQUAL.** Wait until the pump is up to speed to check for equal.

L1-L2       L1-L3       L2-L3

**IF THE PUMP RUNS**, make the following three tests.  
 If not, skip to RESISTANCE MEASUREMENT below.

Measure AC amps through any one motor wire.  AAC  
 Normal range for working pump is 1 - 9 A  
 (a normal AC clamp-on meter will work)  
**cf. Test #6/6A**

DC Volts on 3 motor phases — **YES**, set the meter to **DC** and test as above.  
 Around than 1/10V is good. Around 1/2V is bad.  
 Note here only if bad  V DC

**MOTOR CIRCUIT RESISTANCE (Test #7)**

This will test the integrity of the motor and the wiring to it. This is done with **NO POWER** applied. If you are not familiar with measuring resistance, please refer to your meter’s instruction manual. You will need to use the lowest ohms range on your meter. Hold the probes tightly to the wires and scratch then a little to ensure good contact. Hold tight until the meter display shows the **LOWEST** reading that you can get. Holding the probes with your fingers will not alter the reading.

**DISCONNECT the motor wires** (L1 / L2 / L3) from the junction box.  
 Measure the resistance between each pair on the motor cable

L1-L2  Ω      L1-L3  Ω      L2-L3  Ω

The resistance must be in the range of 0.1 to 1.5 ohms — **ALL EQUAL.**

**Resistance of each pump wire to ground** – There should be **NO** continuity. A meter reading should be much higher than 100K ohms. **DO NOT TOUCH** the wires or probes with your fingers when reading this high range, or your own body continuity will reduce the reading, cf. **Test #8**  Ω

If you see false indications of the lights for **SOURCE LOW** or **TANK LOW**, cf. **Test #9/10/11**

**Water Temperature**

Is the water warmer than 72 °F (22 °C)? This can cause a helical rotor to tighten due to expansion of the rubber stator.  °F / °C

Notes

## 9.6 Electrical Testing Illustrated

These tests are extremely helpful when trying to assess the performance of a system, or locate a fault. These procedures will help you to fill out the Problem Report (Section 9.5).

**Obtaining and using a multimeter** Refer to Section 13.7, and to your meter’s instruction manual. Measuring current (amps) is easiest if you have a clamp-on ammeter, as shown in photos 2A, 4A and 6A.

**Probe input** Some meters give a choice of probe sockets. The negative (black) probe ALWAYS goes in the “COM” (common) socket. The + (red) probe input varies, and is specified below.

**Range** If your meter is “auto-ranging”, this does not apply. Otherwise, use the range than the reading you expect. For example, in Test #1, “normal” voltage is around 80. The proper range may be 100V or 200V, depending on your meter design.

**Access** Open the junction box for access to the terminals. The appearance of your wiring may vary.



**WARNING**  
These tests pose potential shock and burn hazards. Follow appropriate safety precautions.

### Part 1 – Testing the Solar Array (DC)

REFER TO THE NUMBERED PHOTOS ON THE FOLLOWING PAGE

This test refers to a 48V solar array with a PS600 pump set. Your system voltage may vary from that

Test + Photo	TEST DESCRIPTION	NOTES	METER SETTING	+ probe input	NORMAL RESULT	INTERPRETATION
1	PV (solar) array open-circuit voltage	POWER IN disconnect switch must be OFF. Check +/- polarity.	DC volts	V ...	75-85V, lowest in hot weather	1/2x or 2x normal indicates the array is wired wrong
2	PV array short-circuit current	POWER IN switch must be OFF. <b>WARNING Do not connect short circuit for more than 1/2 minute. A spark is normal</b>	DC amps	AMPS10A or higher	Max = PV array watts divided by 65, varies with sun intensity	This indicates if the solar array is producing the expected amount of current, independent of the pump system.
2A	Same, using a clamp-on DC ammeter	<b>WARNING Do not connect short circuit for more than 1/2 minute. A spark is normal</b>	DC amps, check zero-adjust	no probes	"	"
3	DC input voltage during pumping	-	DC volts	V...	around 60V, lowest in hot weather	indicates proper controller input function
4	DC input current during pumping *	-	DC amps	AMPS10A or higher*	Max = PV array watts divided by 70, varies with sun and water lift	This indicates if the solar array is delivering the expected current to the pump system.
4A	Same, using a clamp-on DC ammeter *	This type of meter is easiest to use. There is no need to break circuit.	DC amps	no probes	"	"

\*) **Test 4 or 4A** – The current is determined by both the array AND the load (current draw of the pump system). If the pump is not under full load (like in a bucket), the current may be as little as 1 amp.



**WARNING** To measure voltage, put the + probe in the VOLTS socket on the meter. If it is in an AMPS socket, attempting a voltage reading will cause a short circuit and potential damage.



**BATTERY SYSTEMS** Perform tests # 1, 3 and 4 (4A), as above. Normal result for #1 should equal the battery voltage, typically 44-58V Normal result for #3 is slightly lower, not more than 2V lower.

*Electrical Testing Illustrated continued*

**Test 1 + 2**

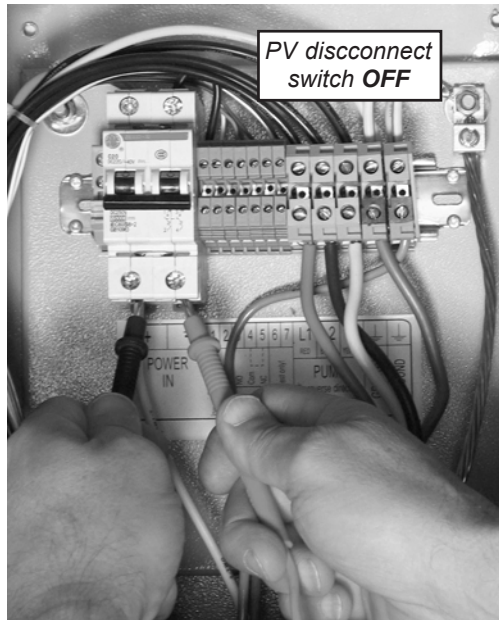

**Test 2a**

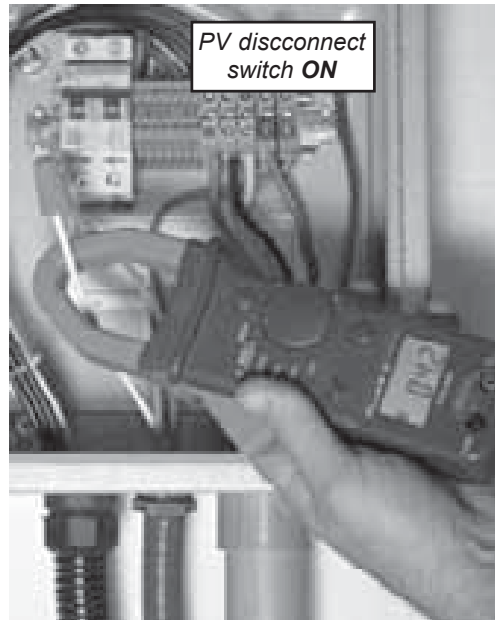

**Test 3** Same as Test 1, but disconnect switched ON

**Test 4**

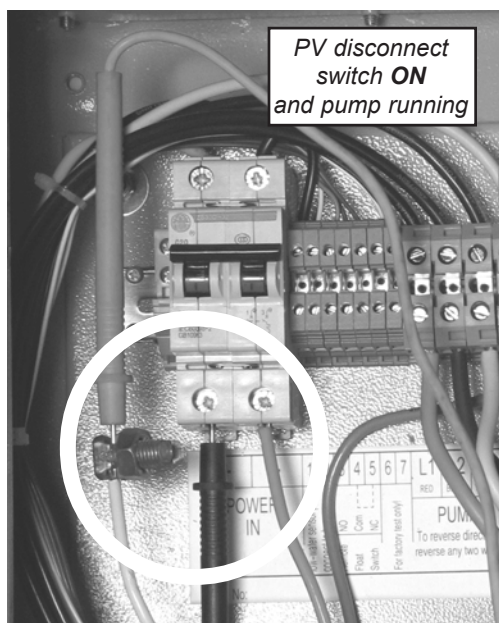

**Test 4a**



Remove one array wire and re-make the connection **THROUGH** your meter. Probe connections must be secure. A clamping device is helpful (split bolt is shown as an example).

DC clamp-on meter must be zero-set first

## Part 2 – Testing the pump circuit (AC and resistance)

REFER TO THE NUMBERED PHOTOS ON THE FOLLOWING PAGE

Test + Photo	TEST DESCRIPTION	NOTES	METER SETTING	+ probe input	NORMAL RESULT	INTERPRETATION
5	Pump speed during pumping	count number of flashes on Pump ON LED			1 to 5 flashes, varies with sun.	Amount of flashes determines speed, and assures that motor is spinning
6	Motor AC current draw	Measure any one of the three motor wires	AC amps	AMPS 10A or higher	1-9 amps See table in Section 9.3	Current is proportional to the torque load on the motor.
6A	Same, using a clamp-on ammeter	This type of meter is easiest to use	AC amps	no probes	"	"
7	Pump circuit resistance *	Power OFF MEASURE ALL L1-L2 / L1-L3 / L2-L3 *	Ohms	Ohms	0.1-1.5 Ohms All three must be equal	Normal and equal means the motor, cable and splices are good.
8 no photo	Pump circuit resist. to ground	Measure from any one pump wire to ground	Ohms	Ohms	more than 100KOhms	Lower reading indicates an insulation fault.

\*) Resistance: Hold the probes tightly to the wire and scratch them to ensure good contact. Hold them still until the meter display shows the LOWEST reading that you can get. Holding the probes with your fingers will not alter the reading.

## Part 3 – Testing the low-water probe circuit

Test + Photo	TEST DESCRIPTION	NOTES	METER SETTING	+ probe input	NORMAL RESULT	INTERPRETATION
9	POWER ON Voltage at terminals 1 & 2	Choose one of these two tests NO PHOTOS	DC volts	V ...	a) 0-2 V b) 5 V	a) Probe in water or bypassed - pump on b) Probe above water or circuit broken - pump off
9	Resistance between probe wires, disconnected from controller		Ohms	Ohms ...	a) 1 KOhm b) Around 1 KOhm	a) Probe in water - OK bypassed - pump on b) Probe above water or circuit broken - pump off

## Part 4 – Testing the full-tank float switch (or pressure switch) circuit

Test + Photo	TEST DESCRIPTION	NOTES	METER SETTING	+ probe input	NORMAL RESULT	INTERPRETATION
<b>IF SWITCH IS NORMALLY OPEN (N.O.) like illustration #10</b>						
10	POWER ON Voltage at terminals 3 & 4	Choose one of	DC volts	V ...	a) 0-2V b) 12V	a) Switch closed (or circuit shorted) - pump off b) Switch open (or circuit broken) - pump on
10	Resistance between switch wires, disconnected from controller	these two tests	Ohms	Ohms ...	a) 100 Ohms or less b) Over 10 KOhms	a) Switch closed (or circuit shorted) - pump off b) Switch open (or circuit broken) - pump on
<b>IF SWITCH IS NORMALLY CLOSED (N.C.) like illustration #11</b>						
11	POWER ON Voltage at terminal 4 & 5	Choose one of	DC volts	V ...	a) 12V b) 0-2V	a) Switch open (or circuit broken) - pump off b) Switch closed (or circuit shorted) - pump on
11	Resistance between switch wires, disconnected from controller	these two tests	Ohms	Ohms ...	a) Over 10 KOhms b) 100 Ohms or less	a) Switch open (or circuit broken) - pump off b) Switch closed (or circuit shorted) - pump on



Electrical Testing Illustrated continued

### Test 5

**Speed indication of Pump.**  
By counting the amount of flashes of the Pump ON LED

**the RPM of the pump can be read off**

- 900 RPM Pump ON LED is ON
- 1200 RPM Pump ON LED flashes once
- 1600 RPM Pump ON LED flashes twice
- 2000 RPM 3 X flashing
- 2400 RPM 4 X flashing
- 2800 RPM 5 X flashing

### Test 6

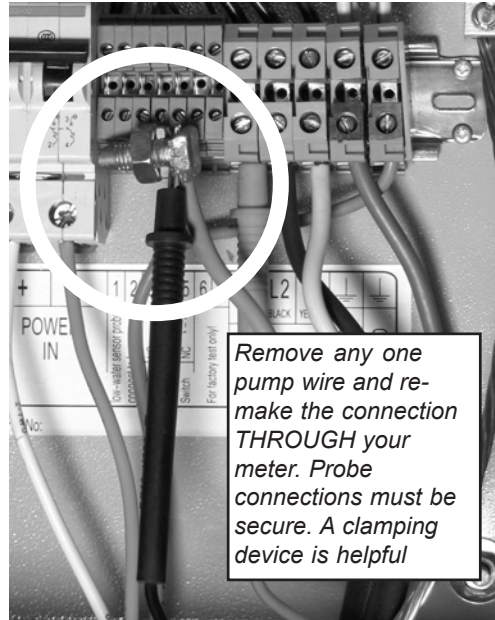

Remove any one pump wire and re-make the connection THROUGH your meter. Probe connections must be secure. A clamping device is helpful

#### Other tests

See Section 9.2:  
Check the low-water probe and check the full-tank float switch

### Test 6A



### Test 7

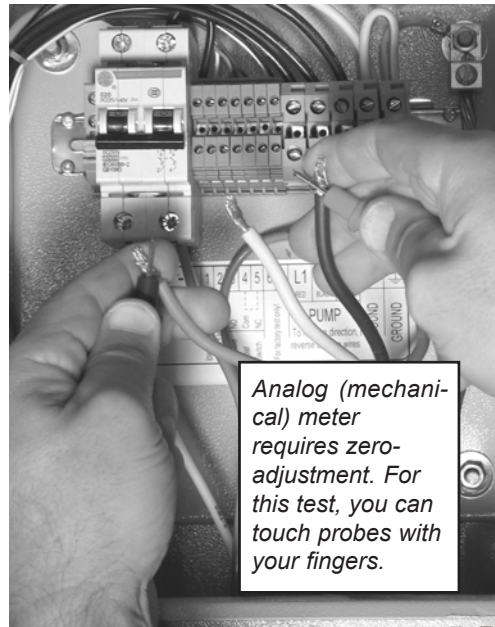

Analog (mechanical) meter requires zero-adjustment. For this test, you can touch probes with your fingers.

### Test 10

If a normally open (N.O.) float switch is used, it is wired this way. To measure switch circuit resistance, **DISCONNECT** the wires from terminals 3 & 4, similar to **Photo #7**.

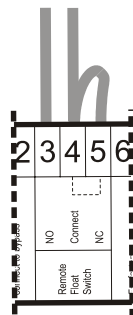

### Test 11

If a normally closed (N.C.) float switch OR pressure switch is used, it is wired this way. To measure switch circuit resistance, **DISCONNECT** the wires from terminals 4 & 5, similar to **Photo #7**.

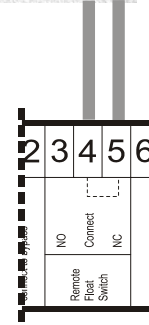

## 10 MAINTENANCE

### 10.1 Controller and Pump

**Controller and junction box** The controller is electronic with no moving or wearing parts. It requires no maintenance. There are rubber gasket seals at the top and bottom, and rubber plugs to seal unused conduit holes. Inspect them to insure that the controller is sealed from moisture, insects, etc. Check that mounting and conduit hardware is tight.

**Motor** The motor is water-lubricated and requires no maintenance. It is permanently sealed and has no brushes or other frequently wearing parts.

**Pump end** The pump mechanism (pump end) is lubricated only by water and requires no maintenance. It may wear after some years, especially if there are abrasive solids in the water. If sand accumulates in the storage tank or pipes as a result of normal pumping, it is best to take periodic measurement of the pump's performance. If the flow rate is less than normal, see Section 9.4. A worn pump end can be replaced in the field, after the pump is pulled from the water source.

### 10.2 Solar Array

**Solar array mounting bolts** Bolts tend to loosen as the array structure flexes in high winds. Check tightness. All bolts should all have lock washers to keep them tight.

**Sun exposure** Cut away any vegetation that will grow enough to block solar illumination. Shading even a small corner of the solar array may stop the pump, or greatly reduce its flow.

**Solar array cleaning** If there is dirt, mineral deposits, bird droppings or other debris stuck to the solar array surface, clean it with water, vinegar or glass cleaner.

**Solar Array Tilt** Inspect the tilt of the array. The optimum tilt angle varies with the season. Some people adjust the tilt twice per year. Other people set it at a single setting as a permanent compromise. Section 4.5 for details.

**Solar Tracker** If the system uses a solar tracker, lubricate the bearings, check mounting bolts and mechanism. Refer to tracker manufacturer's instructions.

### 10.3 Electrical Wiring

**Power wiring** Inspect wires and connections carefully. Any wires that are hanging loose should be secured to prevent them from swinging in the wind. Exposed wiring must be sunlight resistant and in good condition. In the case of a tracking array, look carefully for any wire damage due to rubbing, bending, or pulling as the tracker swings. If wiring was not performed to professional standards, improve it to prevent faults in the future.

**Grounding** Inspect the grounding system carefully. All connections must be tight and free of corrosion. Poor grounding can lead to damage from lightning-induced surges. See Section 5.2.

## 11 MANUFACTURER'S WARRANTY

**HR-xx Pumps, ECDRIVES and PS-xxx controllers are warranted by the manufacturer to be free from defects in material and workmanship for two (2) years from date of purchase.**

Failure to provide correct installation, operation, or care for the product, in accordance with the instruction manual, will void the warranty. Product liability, except where mandated by law, is limited to repair or replacement, at the discretion of the manufacturer or importer.

Neither manufacturer nor importer is responsible for the labor or other charges necessitated by the removal, transportation, or reinstallation of any defective product.

Warranty does not cover damage due to failure to install the device properly, mishandling or abuse, failure to protect circuitry from weather exposure, failure to protect from overheating due to sun exposure or other sources of heat, failure to protect from salt spray or other corrosive factors such as electrolytic action, failure to seal out insects, spiders or rodents, lightning, flood or other acts of nature, or failure of or inappropriate application of peripheral devices including lightning or surge protectors.

Pump Rotor / Stator and Vanes of PS-Boost, ETAPUMP and PS-XXX Motor / Pump are considered to be normal wearing parts, and are not covered under warranty.

Warranty does not cover damage due to sand or abrasive particles in the water, or incompatibility of pump materials with corrosive substances or hydrocarbon or petroleum impurities, or from running the pump with an insufficient supply of water.

No specific claim of merchantability shall be assumed or implied beyond what is printed on the manufacturer's or importer's printed literature. No liability shall exist from circumstances arising from the inability to use the product, or its inappropriateness for any specific purpose. It is the user's responsibility to determine the suitability of the product for any particular use.

## 12 STANDARDS, ENVIRONMENTAL AND TEMPERATURE SPECIFICATIONS

In all cases, it shall be the responsibility of the customer to ensure a safe installation in compliance with local, state and national electrical codes.

PS-xxx controllers are built to DIN-VDE regulations and carry the CE stamp indicating that the European Union electromagnetic interference standards (Dt. EMV) have been fulfilled. Printed circuit boards are conformal-coated against moisture. The enclosure is thick anodized aluminum, gasket-sealed and raintight for any outdoor environment (enclosure class IP55). The controller is suited to tropical conditions according to IEC 68-2-30. The controller is not submersible.

### Temperature Ranges

**Pumps:** Helical rotor pumps (all without C in the model number): For pumps in the standard temperature class, the optimum range of water temperature is 46°F to 72°F (8°C to 22°C).

**Controller:** Ambient air temperature -22°F to 113°F (-30°C to 45°C). The controller has over-temperature protection.

### Storage Temperature

Pump and controller can be stored (not used) in the range of 0°F to 120°F (-20° C to 50 °C).

## 13 REFERENCE SECTION

### 13.1 Principles of Operation

**Solar array** Photovoltaic (PV) cells produce electricity directly from sunlight (not from heat). Light causes electrons to jump from the top layer of the cell, into “holes” in the layer underneath. When a circuit is made between top and bottom layers, electric current flows. Each cell produces about 1/2 volt. As sunlight varies, the current (amps) varies while the voltage stays nearly constant.

PV cells are connected in series for the desired voltage, and sealed under glass to make a “PV module”. The assembly of modules is called a “PV array”. There are no moving or wearing parts in PV modules. The glass used in high quality PV modules is tempered, and is extremely strong. It is tested to federal standards that include resistance to a 1” ice ball traveling at 100 mile per hour.

Some *PS-Pump* systems use a “passive” or active solar tracker, which tilts the array to follow the sun through the day. Daily output can be increased by that feature up to 50%.

Our ETATRACK systems reduce system cost

**Brushless motor system** *PS-Pumps* use a “brushless DC motor system”. This consists of a special 3-phase AC motor (synchronous, permanent magnet), and a controller that changes the solar DC power to 3-phase AC. AC creates a rotating magnetic field that causes the shaft to spin. The motor’s speed is determined by the frequency of the AC power. The controller varies the frequency (and the voltage) to bring the motor up to speed slowly. It then adjusts the motor speed according to the power available from the sun.

Older-technology solar pumps have a traditional DC motor that uses “brushes” (small blocks of carbon-graphite) to conduct current to the spinning part of the motor. Not only do the brushes wear out in a few years, but it is necessary to have air in the motor and a perfect seal to keep water out. The brushless motor is filled with, and lubricated by water. It is similar mechanically to conventional AC submersible motors.

**Controller** The PS-controller starts the pump slowly and adjusts its speed according to the pumping load and the power available from the solar array. Power output from the array is optimally matched to the load by *maximum power point tracker* (MPPT) and *linear current booster* (LCB) functions, to produce maximum power transfer throughout all conditions. The LCB function is analogous to an automatic transmission in an automobile. It starts the pump in “low gear” (it lowers the

array voltage and boosts the current). Under low sun conditions, it stays in “low gear” to resist stalling. As sunlight increases, it advances continuously toward “high gear” (higher voltage). The MPPT system refines the LCB function by tracking changes in the array voltage. Array voltage varies primarily with temperature (it is higher at low temperatures). When the pump stalls in low sunlight, the controller switches the pump off.

The controller converts the DC power from the solar array to 3-phase AC power to run the motor. Due to the special nature of this AC voltage which is made with PWM technology it cannot be measured with a multimeter. Motor speed (RPM) is proportional to the AC frequency. The frequency starts low (about 20 Hz), and increases gradually to a maximum of 3400 RPM (70 Hz).

The float switch circuit operates at 12VDC, carrying maximum current of 4.7mA. The controller has terminals for either normally open (N.O.) or normally closed (N.C.) switching.

The low-water probe circuit applies 5VDC to a probe. The water conducts a small amount of current between the two electrodes of the probe. If the probe is out of the water, the controller stops the pump. When the water level recovers, there is a 20 minute delay before restart.

**Pump end – centrifugal models** Pumps with a MODEL NUMBER CONTAINING “C” use a multi-stage centrifugal pump end, similar to that of conventional well pumps – this is for high volume at 75 feet (23m) or less.

**Pump end – helical rotor models** Pumps with a MODEL NUMBER THAT DOES NOT CONTAIN “C” have a helical rotor pump end (also called “progressive cavity” pump). The rotor fits closely into a rubber stator that has a helical groove of a different pitch. The mismatch between the rotor and stator forms sealed cavities that trap water. As the rotor turns, the cavities progress toward the outlet.



Principles of Operation continued

**HELICAL ROTOR MODELS ONLY**

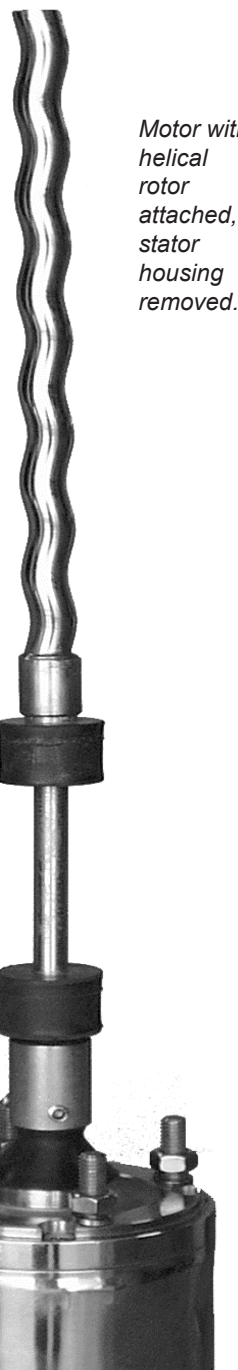
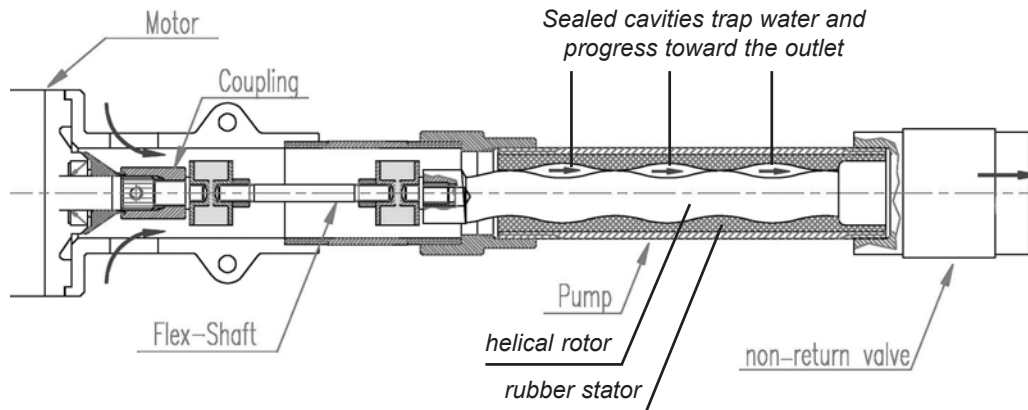

*Motor with helical rotor attached, stator housing removed.*

**Positive displacement action** The helical rotor pump differs from centrifugal pumps in that it maintains high efficiency and lift capacity even at low rotational speeds and low flow rates. This allows *the pump* to work with a small, inexpensive solar array, and to function in low sunlight conditions.

**The helical rotor pump has only one moving part.** It produces a smooth flow and requires no valves to function. It is far more reliable than diaphragm and piston-type solar pumps.

**Self-cleaning action** The rotor sweeps the full surface of the rubber stator with every turn. It is impossible for deposits to accumulate. Solid particles tend to roll away from the contact area, making the pump extremely resistant to abrasion. Particles that are trapped against the rubber are tolerated by the flexibility of rubber.

**Some history** Helical rotor pumps have been used in the oil industry for over 60 years. They are used to pump concrete! They have been used for solar pumping since the 1980's, but were very expensive until *the* LORENTZ helical rotor pump was introduced.

*Close-up of the same rotor. This is a test specimen that pumped extremely sandy water for 500 hours in the test lab. The surface is almost like new, and the pump performs to full specifications.*

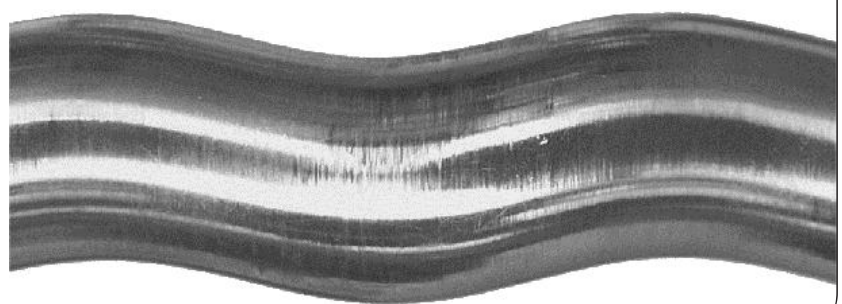

## 13.2 Water Pipe Sizing Chart

### Don't cheat yourself with undersized pipe!

Use this chart to determine the additional head imposed on your pump due to pipe friction, based on flow rate, pipe size and pipe length. Consider the TOTAL pipe length from the pump to the pipe outlet to the tank.

**Pipe fittings** impose additional friction loss. A sharp 90° pipe elbow adds friction approximately equal to 6 feet (2m) of pipe of the same size.



*This Chart applies only to PVC pipe, Schedule 40 (160 PSI), and to polyethylene (PE) pipe with SIDR designation (most common 100 PSI black flexible pipe)*

### Friction Loss in Plastic Pipe with Standard Inside Diameter (SIDR)

Head Loss from friction in vertical m/ft per 100 m/ft of pipe

FLOWRATE		PIPE DIAMETER (inches; nominal, actual)										
		1/2*	3/4	1	1 1/4	1 1/2	2	2 1/2	3	4	5	6
GPM	LPM	0.662	0.82	1.05	1.38	1.61	2.07	2.47	3.07	4.03	5.05	6.06
1	3.8	1.13	0.14	0.05	0.02							
2	7.6	4.16	0.35	0.14	0.05	0.02						
3	11.4	8.55	2.2	0.32	0.09	0.05						
4	15	14.8	3.7	0.53	0.16	0.09	0.02					
5	19	22.2	5.8	0.81	0.25	0.12	0.05					
6	23	31.0	7.9	1.0	0.35	0.18	0.07	0.02				
7	27		10.6	1.5	0.46	0.23	0.08	0.03				
8	30		13.4	1.9	0.58	0.30	0.09	0.05				
9	34		16.9	2.4	0.72	0.37	0.12	0.06				
10	38		20.3	2.9	0.88	0.46	0.16	0.07	0.02			
11	42		24.3	3.5	1.04	0.53	0.18	0.08	0.03			
12	45		28.6	4.1	1.2	0.65	0.21	0.09	0.04			
14	53			5.5	1.6	0.85	0.28	0.12	0.05			
16	61			7.0	2.1	1.1	0.37	0.14	0.06			
18	68			8.7	2.6	1.3	0.46	0.18	0.07			
20	76			10.6	3.2	1.6	0.55	0.21	0.08	0.02		
22	83			13.4	3.8	2.0	0.67	0.25	0.09	0.03		
24	91			14.9	4.4	2.3	0.79	0.30	0.12	0.04		
26	99				5.2	2.7	0.90	0.35	0.14	0.05		
28	106				5.9	3.1	1.0	0.42	0.16	0.05		
30	114				6.7	3.5	1.2	0.46	0.18	0.06		
35	133				8.9	4.6	1.6	0.62	0.23	0.07		
40	152				1.4	5.9	2.0	0.79	0.30	0.09	0.02	
45	171				14.2	7.4	2.5	0.97	0.37	0.12	0.04	
50	190				17.3	9.0	3.0	1.2	0.46	0.14	0.05	
55	208					10.7	3.6	1.4	0.55	0.16	0.06	
60	227					12.5	4.2	1.7	0.65	0.18	0.07	0.02
65	246					14.6	4.9	1.9	0.74	0.22	0.08	0.03
70	265					16.7	5.6	2.2	0.85	0.25	0.09	0.04
75	284					19.0	6.4	2.5	0.97	0.28	0.10	0.05
80	303						7.2	2.8	1.1	0.32	0.12	0.06
85	322						8.1	3.2	1.2	0.37	0.14	0.07
90	341						9.0	3.5	1.4	0.39	0.15	0.08
95	360						9.9	3.9	1.5	0.44	0.16	0.09
100	379						10.9	4.3	1.7	0.49	0.18	0.12
150	569						23.1	9.1	3.5	1.0	0.37	0.16
200	758							15.5	6.0	1.8	0.62	0.28



**SHADED VALUES are velocities over 5 ft per second and should be selected with caution**

\*) 1/2 data applies to polyethylene pipe only. PVC has smaller ID of 0.612"



### 13.3 Wellhead Assemblies for Drilled Wells

To support the drop pipe and seal the wellhead, choose one of these methods:

#### Well Seal System

These methods are NOT specific to solar pumps. The components are available from conventional water well suppliers.

The well seal is a plate that fits on top of the well casing. It provides a seal against contamination, and it supports the weight of the in-well assembly. In a freezing climate, the wellhead must be located in a heated building or in a covered well pit, or the pipe must be made to drain when the pump stops (see Section 13.6 Freeze Protection).

Use metal pipes above ground, for strength. A tee and a plug is used instead of an elbow, because the plug allows direct observation of water level and flow. It also provides a place to attach a lifting device.

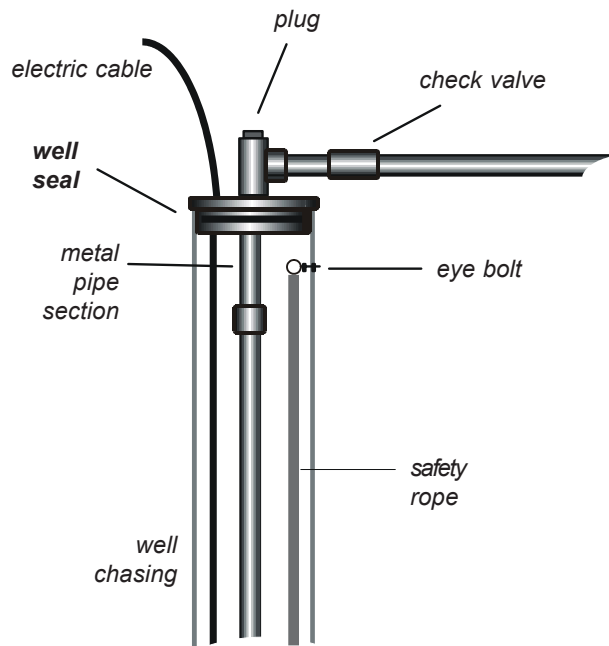

#### Pitless Adapter System

The pitless adapter is a fitting that allows your buried pipe to pass through the well casing underground, without the need to build a covered pit. It provides protection against freezing, flooding, animals and human activities that can damage exposed piping.

After the pitless adapter is installed, the pump can be installed and removed from above, with no further need to dig. The inside half slides apart vertically by means of a dovetail joint and an O-ring. A piece of threaded pipe is used as a temporary tool for installation or removal. Thread it into the socket on the inside half of the adapter.

If the well casing is 4" (inside diameter) the pitless adapter must be designed not to reduce the clearance inside the casing (it clamps around the outside of the casing).

**Two pumps in one well** If you have a well casing of 6" or larger, you may be able to install two pumps in the well, by using two pitless adapters.

#### Check Valve

A check valve (non-return valve) prevents stored water from escaping down the well in case of a leak in your drop pipe. It may also help the pump to start easier if it feeds into a very long pipeline. If you use a weep hole for freeze protection, omit this check valve to allow the pipe to drain.

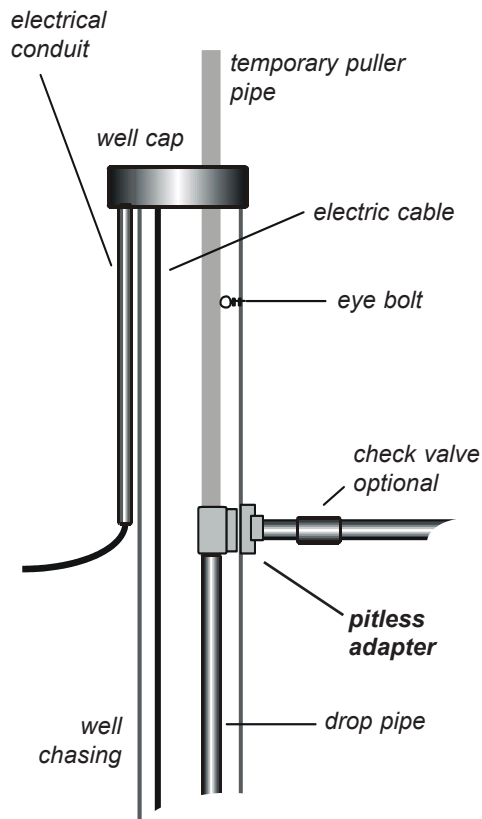

## 13.4 Water Storage for Solar Water Pumps

**Storage Tank Capacity** Generally, storage capacity should equal 3 to 10 days of average water consumption, or more. This depends on the climate and usage patterns. For domestic use in a cloudy climate, 10 days is minimal. In a sunny climate, this allows for a generous safety margin. For deep irrigation of trees (where the soil holds moisture for a week) 3 days' storage may be adequate. For irrigating a garden, 5 days may be adequate. You cannot store too much water!

**Storage Tank Plumbing** This illustration shows many options. They are not all required, but are illustrated for purposes of discussion.

We suggest that you place your normal point of discharge higher than the bottom of your water tank, in order to hold a reserve so that the tank does not run completely dry.

You can lose your water supply under any of these conditions:

1. a period of low sunshine and/or excessive water demand
2. an electrical or mechanical failure in the system
3. a leak in the tank or piping
4. an accidental discharge of stored water

Place a second outlet valve at the bottom level of your storage tank, to use the reserve supply in case of emergency.

**Pipe sizing** The pipe from the pump to the tank may need to be larger than the pump outlet, depending on the flow and the length of pipe. A single pipe may be used for both fill and discharge. In that case, size the pipe for the maximum discharge that you want to accomplish. You may oversize the pipe if there is a chance that you may install a second pump, or larger pump in the future. Sizing the pipe larger than necessary will NOT influence the performance of the system. See Section 13.2, Water Pipe Sizing Chart.

If you plan to use gravity-flow to supply water from the storage tank, be sure the discharge pipe is large enough to allow sufficient flow to meet the maximum water demand without excessive friction loss.

**Pressure of delivery** Every 2.3 feet vertical feet of drop produces 1 PSI of pressure, minus any friction loss (10m produces 1 bar). The volume of water stored in the tank does not effect the pressure delivered.

**Water Purification** Check local health authorities and/or plumbing codes to ensure you will comply with requirements for using a storage tank that is open to the atmosphere, for potable water. Sanitation by means of chlorination, ozone or infrared system may be required or recommended.

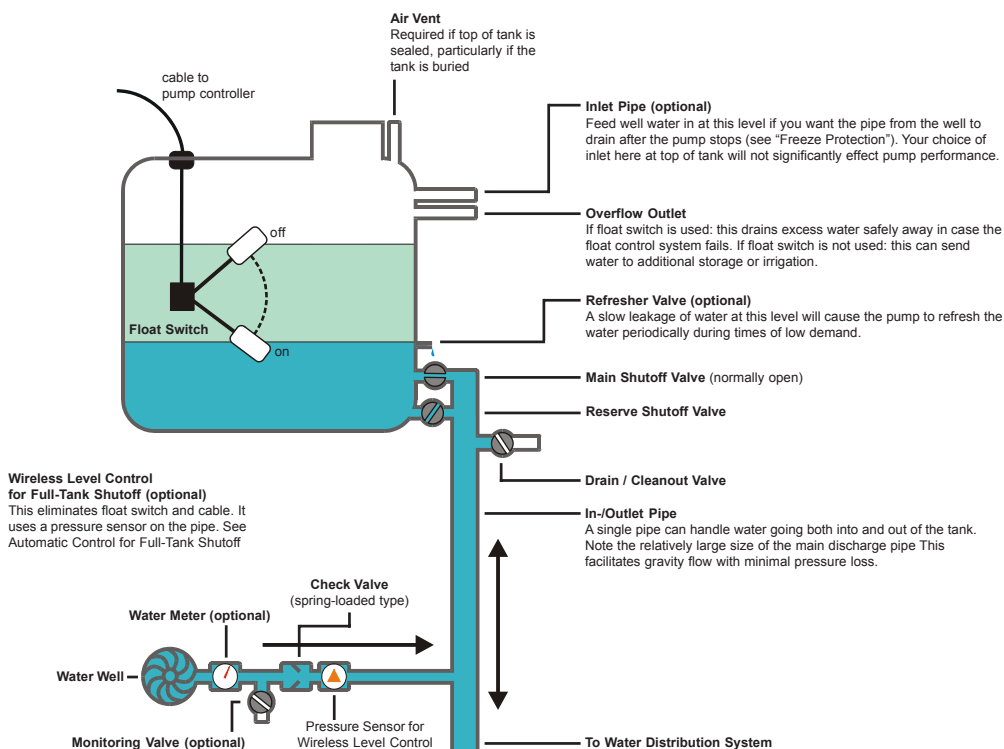

### 13.5 Monitoring a Solar Pump System

**Monitoring the pump** Will you be able to observe the output of your pump at the point of discharge? If not, you may not know if it malfunctions. Consider installing a water meter, or additional valves so that the flow can be directly observed. (See illustration in Section 13.4)

**Monitoring the water level in your storage tank** Will you be able to observe the level of water in your tank? If you cannot easily see into your storage tank, here are some methods of tank monitoring.

1. dipstick in the air vent
2. float with a visible rod that protrudes through the top of the tank
3. clear sight-tube alongside the tank
4. precision pressure gauge (note: 1 PSI = 2.3 feet)

### 13.6 Freeze Protection for Solar Water Pumps

In a cold climate, water can freeze in a pipe and block the water flow. This will cause an electrical overload that will cause the pump to stop.

**Pressure relief** If there is any possibility of a pipe freezing, install a pressure relief valve to prevent excess pressure in the pump line. Install it below frost line. Adjust the valve to open if the pressure exceeds normal. This is especially important for helical rotor pumps (model number not containing “C”) which can develop very high pressure.

**Burial of pipe** The best way to prevent freezing is to bury all piping below frost line. The modern method of burial at the wellhead is to install a pitless adapter (see section 13.3, Wellhead Assemblies for Drilled Wells).

**Weep hole** If you have above-ground piping that must be drained for freeze protection, make a tiny “weep hole” in the drop pipe, below frost line. This will cause a constant (but very small) leakage of water back into the well. When the pump stops, the pipe will drain back slowly. The pipe must be sloped without low spots, so it drains completely. In plastic pipe, a weep hole can be made with a hot needle or an extremely small drill bit, or a needle valve can be installed and adjusted.

**Weep hole – “high tech” version** The most reliable way to control dripping is to use a “drip emitter” made for drip irrigation systems. It will resist accumulation of debris and

mineral deposits far better than a simple hole or a needle valve. Emitters are available from irrigation suppliers, nurseries, and many hardware stores. They are rated in gallons (liters) per hour. The most common ones are in the range of 1-2 gallons (4-8 liters) per hour. Use a relatively fast one for best reliability, especially if you get mineral deposits. Drill a hole in the pipe to fit the emitter, and push the emitter into the hole.

Drip emitters are made for a pressure limit of about 40 PSI (2.8 bar). This limits the vertical lift above the emitter to about 90 feet (28 m). In cases of relatively high lift, use a “pressure compensated” emitter. It will maintain a relatively constant drip rate as the pressure varies. This will reduce water loss when the pump is running.

**Polyethylene pipe** Flexible “poly pipe” (PE) has proven to tolerate repeated freezing. Connections may loosen from ice expansion, but the pipe is not damaged. Poly pipe is often used in places where pipe may freeze accidentally or occasionally. See Section 7.3 for precautions regarding PE pipe. If you plan to bury PE pipe, observe further precautions supplied by the pipe manufacturer.



**WARNING** Do not install the pump with its check valve removed.



**Question:** Will the pump drain back when it stops?

**Answer:** NO! The pump has a check valve that stops water from draining back down when it stops. A helical rotor pump will not drain back even if the check valve is removed.

## 13.7 Selecting and Using Meters for Electrical Testing

Most on-site trouble shooting requires a test instrument called a multimeter which can be obtained from an electric supply, electronic supply, automotive or hardware store. It will measure DC and AC volts, current (amps) and resistance (ohms, symbolized by  $\Omega$ ). Here are some criteria for selecting a meter for testing.

**Digital or analog meter?** A digital meter is best. An **autoranging digital** meter is easiest to use, especially for a beginner. An analog (mechanical) meter is good if it is of high quality and at least 3" (75 mm) wide.

**Resistance ranges** The meter must read in the 0-10 Ohm range to one decimal place. This includes all but the smallest and cheapest digital meters, and analog meters that have at least three resistance ranges.

**Ammeter ranges** These are the options, with notes about cost and benefits. \$ costs are US\$, typical in USA.

1. Multimeter with milliamp range but no Amp range (under \$35) – This will be useful for voltage and resistance measurement, but not for current. It is useful, but not adequate for all troubleshooting.
2. Multimeter with amp range to 10A or more, without clamp-on capability (\$25-\$150) – This will measure PV array current and pump running current. A wire must be disconnected in order to measure current (current must flow through the meter). Inexpensive meters are delicate and not suited to professional use.
3. DC/AC clamp-on ammeter (\$50-\$300) – a clamp-on meter allows measurement of current without disconnecting wires. We strongly recommend this type of meter for solar pumps and other electrical equipment. It makes the job much safer and easier. Fluke Model 33 or 36 are the professional favorites. Cheaper ones are less reliable and should be checked periodically for accuracy.

### **Use two meters and clips for easier testing.**

It is often helpful to measure voltage and current simultaneously. An inexpensive meter is adequate for voltage, because precision is not necessary. Clip-wires or clip-on probes are very helpful if you don't have three hands.

**Resistance readings** are always taken with NO POWER applied to the circuit. Always use the LOWEST range that produces a reading

(RX1 is the lowest range). An "auto-ranging" meter will adjust its range automatically.

**Zero adjustment** Some meters have a zero-adjustment to insure accuracy. This applies to analog meters when measuring resistance, and to clamp-on DC ammeters. Be sure to set the zero if necessary!

## 13.8 Measuring Solar Energy Intensity

To accurately evaluate a solar-direct solar pump, it is necessary to measure sun intensity. For example, if the solar pump is producing around 60% of the specified maximum flow, and you measure the sun intensity (in the same plane as the array) as 60% of full sun, you know the system is working properly.

The *Daystar Meter* is a hand-held instrument that measures sun intensity using a solar (PV) cell similar to those used to power your solar pump. It displays the solar potential in watts per square meter ( $W/m^2$ ). The industry-standard for full sun intensity is  $1000 W/m^2$ , so a reading of 600 indicates 60% intensity.

The meter costs less than \$150 (in USA). Order directly from the manufacturer: Daystar, Inc., 3240 Majestic Ridge, Las Cruces, NM 88011 USA, tel. (505) 522-4943 [daystarpv@mac.com](mailto:daystarpv@mac.com) [www.raydec.com/daystar](http://www.raydec.com/daystar)



**WARNING** Read the instructions that come with your meter, and follow the safety warnings.



**WARNING** Attempting to read current (amps) between the two poles of a power circuit causes a potentially dangerous short circuit. Connect the probes IN SERIES with the circuit – see your meter's instruction manual. To read voltage, the red probe must NOT be in the Amps socket. This will cause a short circuit.

## 13.9 Glossary of Solar Electricity and Water Pumping

### Basic Electricity

**AC** - Alternating Current, the standard form of electrical current supplied by the utility grid and by most fuel-powered generators. The polarity (and therefore the direction of current) alternates. In U.S.A., standard voltages for small water pumps are 115V and 230V. Standards vary in different countries. See *inverter*.

**DC** - Direct Current, the type of power produced by photovoltaic panels and by storage batteries. The current flows in one direction and polarity is fixed, defined as positive (+) and negative (-). Nominal system voltage may be anywhere from 12 to 180V. See *voltage, nominal*.

**Current** - The rate at which electricity flows through a circuit, to transfer energy. Measured in Amperes, commonly called Amps. Analogy: flow rate in a water pipe.

**Efficiency** - The percentage of power that gets converted to useful work. Example: An electric pump that is 60% efficient converts 60% of the input energy into work - pumping water. The remaining 40% becomes waste heat.

**Energy** - The product of power and time, measured in Watt-Hours. 1000 Watt-Hours = 1 Kilowatt-Hour (abbreviation: KWH). Variation: the product of current and time is Ampere-Hours, also called Amp-Hours (abbreviation: AH). 1000 watt consumed for 1 hour = 1 KWH. See *power*.

**Converter** - An electronic device for DC power that steps up voltage and steps down current proportionally (or vice-versa). Electrical analogy applied to AC: See *transformer*. Mechanical analogy: gears or belt drive.

**Inverter** - An electronic device that converts low voltage DC to high voltage AC power. In solar-electric systems, an inverter may take the 12, 24, or 48 volts DC and convert it to 115 or 230 volts AC, conventional household power.

**Power** - The rate at which work is done. It is the product of Voltage times Current, measured in Watts. 1000 Watts = 1 Kilowatt. An electric motor requires approximately 1 Kilowatt per Horsepower (after typical efficiency losses). 1 Kilowatt for 1 Hour = 1 Kilowatt-Hour (KWH).

**Three-Phase AC** - Three phase power is AC that is carried by three wires. Power waves are applied in a sequence. Three-phase is

used for large industrial motors, variable-speed motors, and brushless solar water pump motors. Analogy: 3-cylinder engine.

**Transformer** - An electrical device that steps up voltage and steps down current proportionally (or vice-versa). Transformers work with AC only. For DC, see *converter*. Mechanical analogy: gears or belt drive.

**Utility Grid** - Commercial electric power distribution system. Synonym: *mains*.

**Voltage** - The measurement of electrical potential. Analogy: Pressure in a water pipe.

**Voltage Drop** - Loss of voltage (electrical pressure) caused by the resistance in wire and electrical devices. Proper wire sizing will minimize voltage drop, particularly over long distances. Voltage drop is determined by 4 factors: wire size, current (amps), voltage, and length of wire. It is determined by consulting a wire sizing chart or formula available in various reference tests. It is expressed as a percentage. Water analogy: Friction Loss in pipe.

**Voltage, Nominal** - A way of naming a range of voltage to a standard. Example: A "12 Volt Nominal" system may operate in the range of 11 to 15 Volts. We call it "12 Volts" for simplicity.

### Solar Electricity

**Charge Controller** - A device that regulates the charge current to a battery in order to prevent overcharge. It prevents excessive voltage and maximizes the longevity of a battery. It may also contain other control functions (see Low Voltage Disconnect).

**Deep Cycle Battery** - Batteries that are designed to discharge as much as 80% of their capacity, hundreds of times. They differ from engine-starting batteries by having thicker plates and different metal alloys.

**Low Voltage Disconnect** - A control function in a battery-based power system in which the load or loads are disconnected before the battery gets over-discharged. Over-discharge will damage a lead-acid battery. Typical settings for a 12V system are 10.5 or 11V disconnect and 12.5 or 13V reconnect.

**Photovoltaic** - The phenomenon of converting light to electric power. Photo = light, Volt = electricity. Abbreviation: *PV*.

**PV** - The common abbreviation for *photovoltaic*.



Courtesy of  
**Dankoff Solar  
Products, Inc.**

2810 Industrial Rd.  
Santa Fe, NM USA 87505  
(505) 473-3800  
[www.dankoffsolar.com](http://www.dankoffsolar.com)



**PV Array** - A group of PV (photovoltaic) modules (also called *panels*) arranged to produce the voltage and power desired.

**PV Array-Direct** - The use of electric power directly from a photovoltaic array, without storage batteries to store or stabilize it. Most solar water pumps work this way, utilizing a tank to store water.

**PV Cell** - The individual photovoltaic device. Most PV modules are made with around 36 or 72 silicon cells, each producing about 1/2 volt.

**PV Module** - An assembly of PV cells framed into a weatherproof unit. Commonly called a "PV panel". See *PV array*.

**Solar Tracker** - A mounting rack for a PV array that automatically tilts to follow the daily path of the sun through the sky. A "tracking array" will produce more energy through the course of the day, than a "fixed array" (non-tracking) particularly during the long days of summer.

**Voltage, Open Circuit** - The voltage of a PV module or array with no load (when it is disconnected). A "12 Volt Nominal" PV module will produce about 20 Volts open circuit. Abbreviation: Voc.

**Voltage, Peak Power Point** - The voltage at which a photovoltaic module or array transfers the greatest amount of power (watts). A "12 Volt Nominal" PV module will typically have a peak power voltage of around 15-17 volts. The solar array for a PV array-direct solar pump should reach this voltage in full sun conditions, or a multiple of this voltage. Abbreviation: Vpp.

## ***Pumps & Related Components***

**Booster Pump** - A surface pump used to increase pressure in a water line, or to pull from a storage tank and pressurize a water system. See *surface pump*.

**Centrifugal Pump** - A pumping mechanism that spins water in order to push it out by means of centrifugal force. See also *multi-stage*.

**Check Valve** - A valve that allows water to flow one way but not the other.

**Diaphragm Pump** - A type of pump in which water is drawn in and forced out of one or more chambers, by a flexible diaphragm. Check valves let water into and out of each chamber.

**Float Switch** - An electrical switch that

responds to changes in water level. It may be used to prevent overflow of a tank by turning a pump off, or to prevent a pump from running dry when the source level is low.

**Float Valve** - A valve that responds to changes in water level. It is used to prevent overflow of a tank by blocking the flow of water.

**Foot Valve** - A check valve placed in the water source below a surface pump. It prevents water from flowing back down the pipe and "losing prime". See *check valve* and *priming*.

**Helical Rotor Pump** - A pump with a helix-shaped rotor that fits closely into a rubber stator that has a helical groove. It forms sealed cavities that trap water. As the rotor turns, the cavities move toward the outlet. See *positive displacement pump*. Synonyms: progressive cavity pump, screw pump.

**Impeller** - The device that spins inside of a centrifugal pump, in order to develop centrifugal force.

**Jet Pump** - A surface-mounted centrifugal pump that uses an "ejector" (venturi) device to augment its suction capacity. In a "deep well jet pump", the ejector is down in the well, to assist the pump in overcoming the limitations of suction. (Some water is diverted back down the well, causing an increase in energy use.)

**Multi-Stage Centrifugal** - A centrifugal pump with more than one impeller and chamber, stacked in a sequence to produce higher pressure. Conventional AC deep well submersible pumps and some solar submersibles work this way.

**Positive Displacement Pump** - Any mechanism that seals water in a chamber, then forces it out by reducing the volume of the chamber. Examples: piston, diaphragm, helical rotor, vane. Used for low volume and high lift. Contrast with *centrifugal*. Synonyms: volumetric pump, force pump.

**Priming** - The process of hand-filling the suction pipe and intake of a surface pump. Priming is generally necessary when a pump must be located above the water source. A *self-priming* pump is able to draw some air suction in order to prime itself, at least in theory. See *foot valve*.

**Pulsation Damper** - A device that absorbs and releases pulsations in flow produced by a piston or diaphragm pump. Consists of a chamber with air trapped within it or a length of flexible tube.



*Glossary of Solar Electricity and Water Pumping continued*

**Pump Jack** - A deep well piston pump. The piston and cylinder is submerged in the well water and actuated by a rod inside the drop pipe, powered by a motor at the surface. This is an old-fashioned system that is still used for extremely deep wells, including solar pumps as deep as 1000 feet.

**Self-Priming Pump** - See *priming*.

**Submersible Pump** - A motor/pump combination designed to be placed entirely below the water surface.

**Surface Pump** - A pump that is not submersible. It must be placed no more than about 20 ft. above the surface of the water in the well. See *priming*. (Exception: see *jet pump*)

### **Solar Pump Components**

**DC Motor, Brush-Type** - The traditional DC motor, in which small carbon blocks called "brushes" conduct current into the spinning portion of the motor. They are used in most solar surface pumps and in some low-power solar submersibles. The motor chamber must be filled with air and perfectly sealed from moisture. Brushes naturally wear down after years of use, and must be replaced periodically.

**DC Motor, Brushless** - High-technology motor used in more advanced solar submersibles. An electronic system is used to precisely alternate the current, causing the motor to spin. See *three-phase AC*. A submersible brushless motor is filled with water and requires no maintenance.

**DC Motor, Permanent Magnet** - All DC solar pumps use this type of motor in some form. Being a variable speed motor by nature, reduced voltage (in low sun) produces proportionally reduced speed, and causes no harm to the motor. Contrast: *induction motor*

**Induction Motor (AC)** - The type of electric motor used in conventional single-phase AC water pumps. It requires a high surge of current to start, and a stable voltage supply, making it relatively expensive to run from by solar power. See *Inverter*.

**Linear Current Booster (LCB)** - An electronic device which varies the voltage and current of a PV array to match the needs of an array-direct pump, especially a *positive displacement* pump. It allows the pump to start and to run under low sun conditions without stalling. Electrical analogy: variable

transformer. Mechanical analogy: automatic transmission. Also called *pump controller*. See *pump controller*.

**Maximum Power Point Tracking (MPPT)** - An added refinement in some linear current boosters, in which the input voltage tracks the variations of the output voltage of the PV array to draw the most possible solar power under varying conditions of temperature, solar intensity and load.

**Pump Controller** - An electronic device that controls or processes the power to a pump. It may perform any of the following functions: stopping and starting the pump; protection from overload; DC-to-AC conversion; voltage conversion; power matching (see *linear current booster*). It may also have provisions for low-water shutoff and full-tank shutoff devices, and status indicators.

### **Water Well Components**

**Borehole** - Synonym for drilled well, especially outside of North America.

**Casing** - Plastic or steel tube that is permanently inserted in the well after drilling. Its size is specified according to its inside diameter.

**Cable Splice** - A joint in electrical cable. A submersible splice is protected by a water-tight seal.

**Drop Pipe** - The pipe that carries water from a pump in a well, up to the surface. It also supports the pump.

**Perforations** - Slits cut into the well casing to allow groundwater to enter. May be located at more than one level, to coincide with water-bearing strata in the earth.

**Pitless Adapter** - A special pipe fitting that fits on a well casing, below ground. It lets the pipe pass horizontally through the casing so that no pipe is exposed above ground where it could freeze. The pump may be installed and removed without further need to dig around the casing. This is done by using a 1" threaded pipe as a handle.

**Safety Rope** - Rope used to secure the pump in case of pipe breakage.

**Submersible Cable** - Electrical cable designed for in-well submersion. Conductor sizing is specified in square millimeters, or (in North America) by American Wire Gauge (AWG) in which a higher number indicates smaller wire. It is connected to a pump by a *cable splice*.

**Well Seal** - Top plate of a well casing that provides a sanitary seal and support for the drop pipe and pump. Alternative: See *pitless adapter*

## Water Well Characteristics

**Driller's Log** - The document on which well characteristics are recorded by the well driller. In most states, drillers are required to register all water wells and to send a copy of the log to a state office. This supplies hydrological data and well performance test results to the well owner and the public. Synonym: *well record*.

**Drawdown** - Lowering of level of water in a well due to pumping.

**Drawdown level** - Depth to the water surface in a well while it is being pumped.

**Recovery Rate** - Rate at which groundwater refills the casing after the level is drawn down. This is the term used to specify the production rate of the well.

**Static Water Level** - Depth to the water surface in a well under static conditions (not being pumped). May be subject to seasonal changes or lowering due to depletion.

**Wellhead** - Top of the well.

## Pump System Engineering

**Friction Loss** - The loss of pressure due to flow of water in pipe. This is determined by 4 factors: pipe size (inside diameter), pipe material, flow rate, and length of pipe. It is determined by consulting a friction loss chart available in an engineering reference book or from a pipe supplier. It is expressed in PSI or Feet (equivalent additional feet of pumping). Pipe fittings, especially 90° elbows, impose additional friction.

**Head** - See synonym: *vertical lift*.

**Suction Lift** - Applied to surface pumps: Vertical distance from the surface of the water in the source, to a pump located above the surface. This distance is limited by physics to around 20 feet at sea level (subtract 1 ft. per 1000 ft. altitude) and should be minimized for best results.

**Submergence** - Applied to submersible pumps: Distance below the static water level, at which a pump is set.

**Total Dynamic Head** - *vertical lift + friction loss* in piping (see *vertical lift* and *friction loss*).

**Vertical Lift** - The vertical distance that water is pumped. This determines the pressure that the pump pushes against. Total vertical lift = vertical lift from surface of water source up to the discharge in the tank + (in a pressure system) discharge pressure. Synonym: *static head*. Note: Horizontal distance does NOT add to the vertical lift, except in terms of pipe friction loss. NOR does the volume (weight) of water contained in pipe or tank. Submergence of the pump does NOT add to the vertical lift. See *total dynamic head*.

## Water Distribution

**Cut-In Pressure** and **Cut-Out Pressure** - See *pressure switch*.

**Gravity Flow** - The use of gravity to produce pressure and water flow. A storage tank is elevated above the point of use, so that water will flow with no further pumping required. A booster pump may be used to increase pressure. 2.31 vertical feet = 1 PSI. 10 vertical meters = 1 bar. See *pressure*.

**Head** - See *vertical lift* and *total dynamic head*. In water distribution, synonym: *vertical drop*. See *pressure*.

**Open Discharge** - The filling of a water vessel that is not sealed to hold pressure. Examples: storage (holding) tank, pond, flood irrigation. Contrast: *pressure tank*.

**Pressure** - The amount of force applied by water that is either forced by a pump, or by the gravity. Measured in pounds per square inch (PSI) or bar (atmospheres). PSI = vertical lift (or drop) in Feet / 2.31. Metric: 1 Bar = vertical lift (or drop) of 10 vertical meters.

**Pressure Switch** - An electrical switch actuated by the pressure in a pressure tank. When the pressure drops to a low set-point (cut-in) it turns a pump on. At a high point (cut-out) it turns the pump off.

**Pressure Tank** - A fully enclosed tank with an air space inside. As water is forced in, the air compresses. The stored water may be released after the pump has stopped. Most pressure tanks contain a rubber bladder to capture the air. If so, synonym: *captive air tank*.

*Glossary of Solar Electricity and Water Pumping continued*

**Pressure Tank Precharge** - The pressure of compressed air stored in a captive air pressure tank. A reading should be taken with an air pressure gauge (tire gauge) with water pressure at zero. The air pressure is then adjusted to about 3 PSI lower than the cut-in pressure (see Pressure Switch). If precharge is not set properly, the tank will not work to full capacity, and the pump will cycle on and off more frequently.

For permission to reproduce and distribute *Glossary of Solar Electricity and Water Pumping*, please contact Dankoff Solar Products. Citation of the source and copyright is required.

Copyright © 1997-2005 by Dankoff Solar Products, Inc.  
All rights reserved

**13.10 Calculating Pumping Efficiency and Power Requirement**

This formula lets you calculate the wire-to-water energy efficiency of any electric pumping system

**% Efficiency = (Vert. Feet X GPM X 18.8) / Watts**

**Metric: % Efficiency = ( Vert. meters X LPM X 16 ) / Watts**

% is expressed as a whole number ("45" means 45%)

To estimate power requirement for any proposed pumping job

**Watts = ( Vert. feet X GPM X 18.8 ) / pump efficiency %**

**Metric: Watts = (Vert. meters X LPM X 16) / % pump efficiency**

Average efficiency for AC electric pump is around 35%, solar pumps range 40-60%.

## 13.11 System Wiring Diagram for Solar-direct (non-battery) System

