

Models:

- FLEXmax 80: 80 amps maximum continuous output current (up to 40°C without thermal derating)
- FLEXmax 60: 60 amps maximum continuous output current (up to 40°C without thermal derating)

Features:

- Maximum Power Point Tracking
- Supports 12, 24, 36, 48, and 60 Vdc battery voltages
- Backlit display screen (LCD) with 80 characters (4 lines, 20 characters per line)
- Last 128 days of operational data logging
- Voltage step-down capability allowing a higher PV array voltage configuration
- Manual and automatic equalize cycles

Screen Versions:

- English
- Spanish
- Australian (English with different default settings)

Maximum PV Input Wattage per Charge Controller

Battery Bank Voltage	Maximum PV Input Wattage for the FLEXmax 80	Maximum PV Input Wattage for the FLEXmax 60
12 Vdc	1000 W	750 W
24 Vdc	2000 W	1500 W
36 Vdc	3000 W	2250 W
48 Vdc	4000 W	3000 W
60 Vdc	5000 W	3750 W

FLEXmax Charge Controller

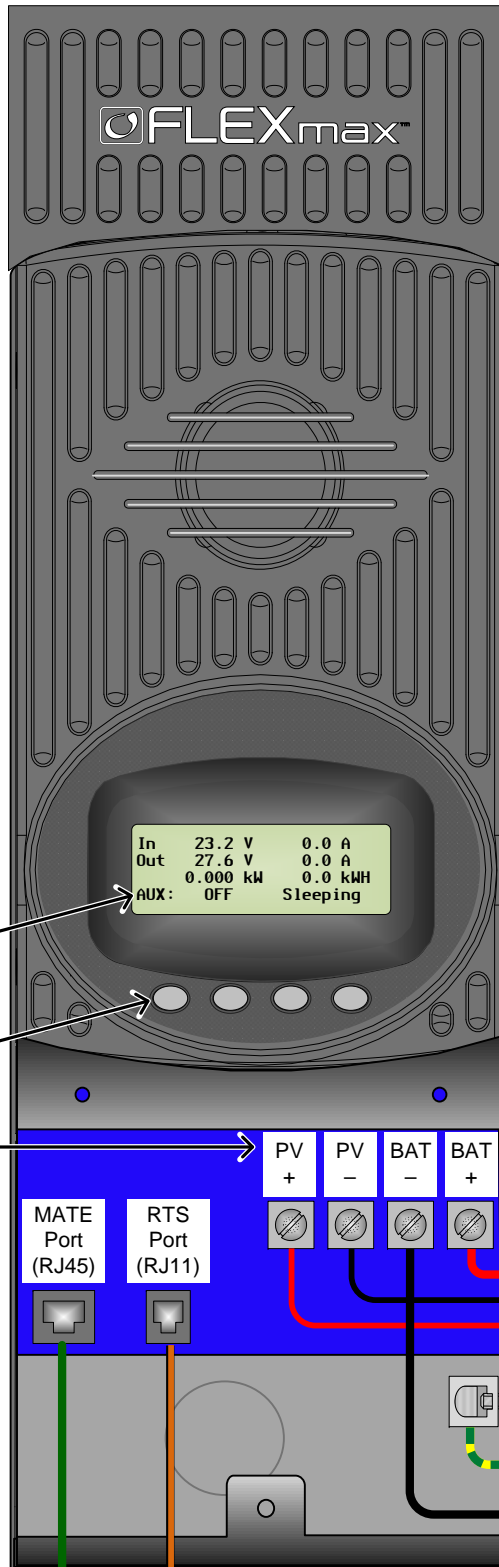

IMPORTANT: Example only. Actual wiring may vary. All configurations must comply with local and national electric codes. Consult your local electric authority to ensure compliance.

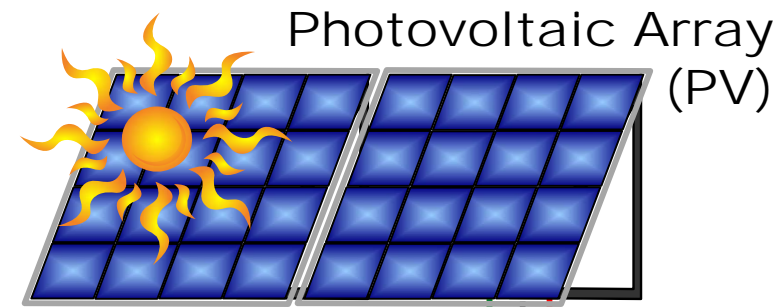

PV Combiner Box

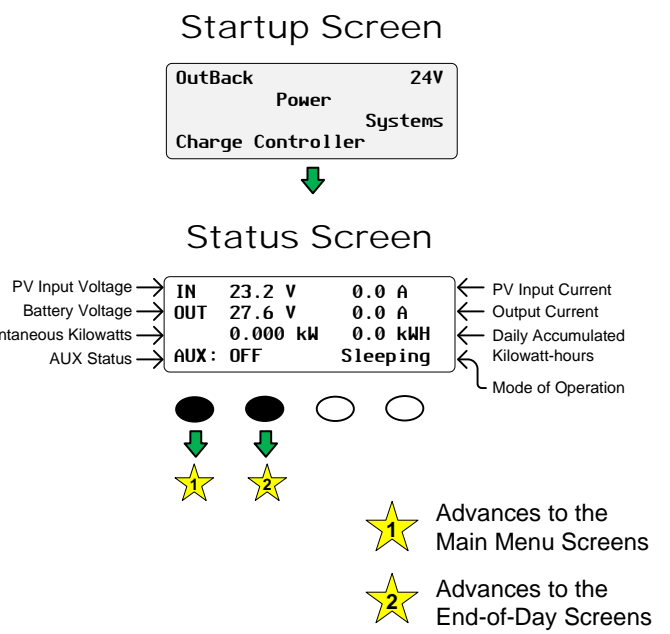
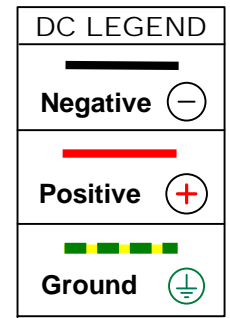
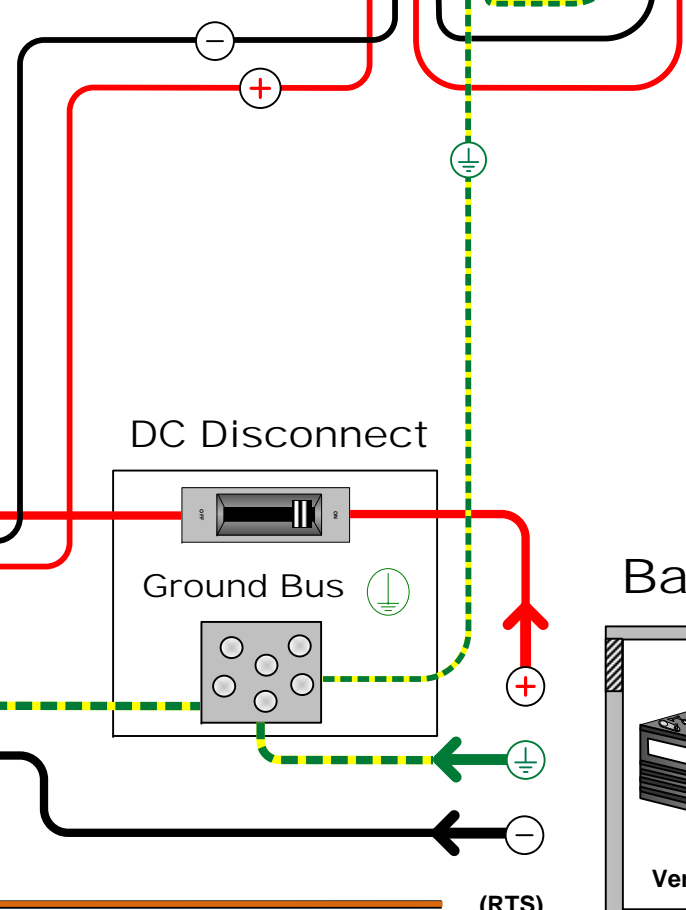
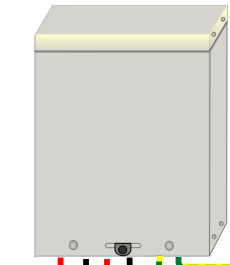

Navigation:

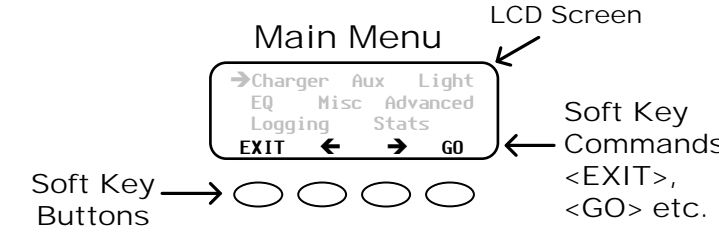

Soft Key Color Code:

- Available menus
- Select this option to proceed
- Adjusts the set points value
- Selects a function (e.g., ON, OFF, AUTO)
- Switches between devices on the ports of the Communications HUB
- Navigation colors

NOTE: Soft key functions will vary depending on the selected menu and are defined by the word above the key in the LCD.

↓ ↑ → ← Indicates a 1-screen movement within a menu. These are color-coded according to their function or purpose.

If accompanied by a dashed line, pressing that soft key will return the user to the location identified by the dashed line. This will vary depending on the devices in the system.

NOTE: See the FLEXmax Series Owner's Manual for details on the settings available in the main menu.

To change the Language, Screen Version or System Voltage:

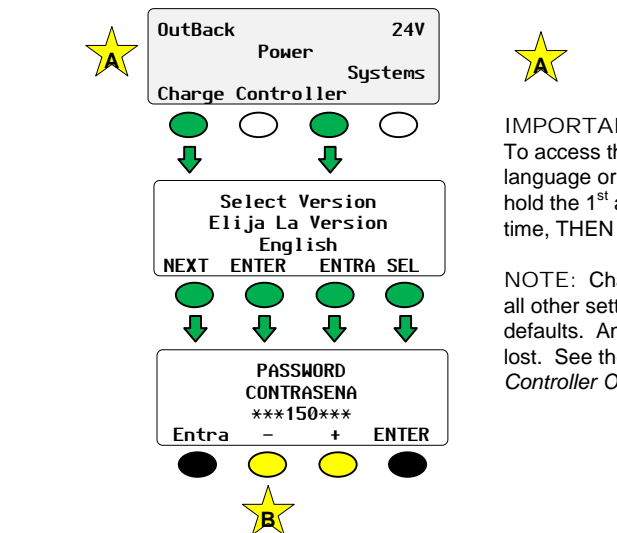

IMPORTANT:
To access the screens to change the language or system voltage, press and hold the 1st and 3rd soft key at the same time, THEN CLOSE THE DC BREAKERS.

NOTE: Changing these setting will revert all other settings back to the factory defaults. Any customized settings will be lost. See the *FLEXmax Series Charge Controller Owner's Manual* for details.

1. Press the <-> soft key until "141" is displayed on the LCD.
2. Press the <ENTER> or <ENTRA> soft key to accept the password and move forward to the Select Version Screen.

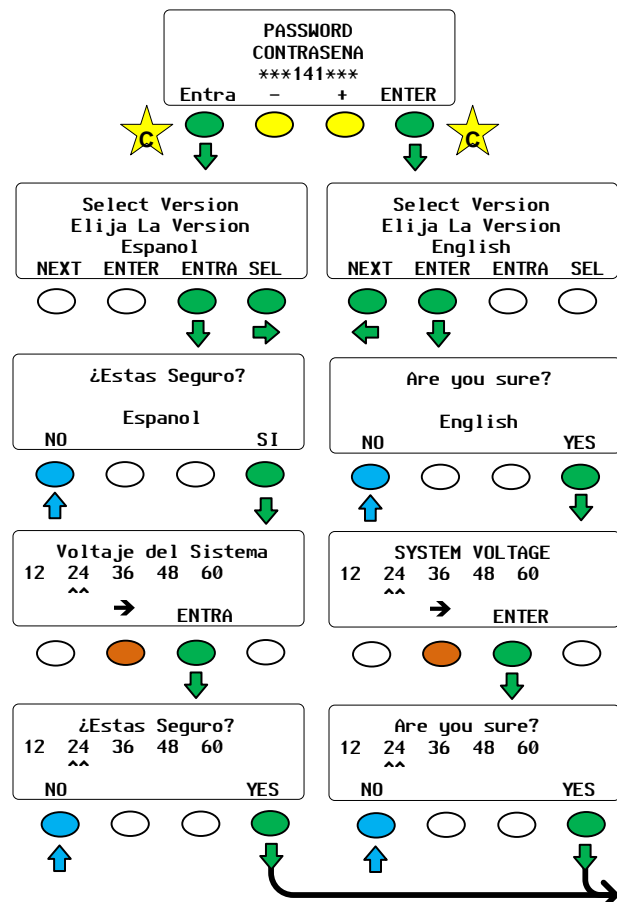

The Spanish Status Screen is not shown in this illustration. It is available in the Spanish translation of this document.

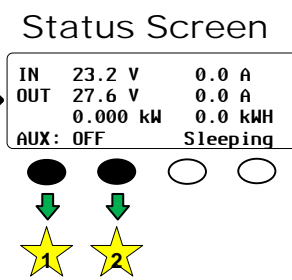

To access the Main Menu:

Status Screen

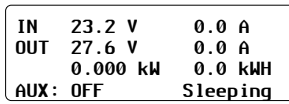

Main Menu Screen

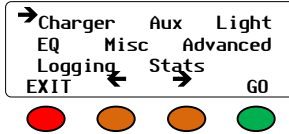

To select a menu from the Main Menu, press the <←> or the <→> soft key to move the cursor (→). When the is next to the desired menu, press <GO>.

- **Charger**—CHARGER SETUP
Adjusts the Current Limit, Absorbing, and Float recharging voltage set points
- **Aux**—AUX OUTPUT CONTROL
Secondary control circuit for a vent fan, AGS, error alarm, and other system-related additions
- **Light**—BACKLIGHT CONTROL
Adjusts the backlighting of LCD screen and soft key buttons
- **EQ**—BATTERY EQUALIZE
Activates battery equalization (manually or automatically)
- **Misc**—MISCELLANEOUS
Additional settings and service information
- **Advanced**—ADVANCED MENU
Optimizes/fine-tunes the charge controller
- **Logging**—DATA LOGGING
Displays recorded power production information
- **STATS**—STATISTICS
Displays recorded peak system information and cumulative kilowatt-hours and amp-hours

Main Menu Screen

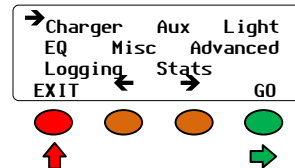

Press <↓> to move the → next to the desired setting.
Press <-> or <+> to adjust the setting.
Press <EXIT> to return to the main menu.

Charger Screen

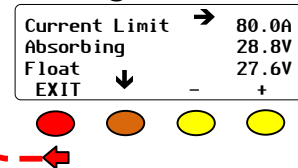

End-of-Day (EOD) Summary Screens

NOTE: The values shown in this illustration will vary depending on the nominal DC voltage.

Status Screen

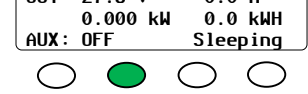

End-of-Day (EOD) Summary Screen (current day)

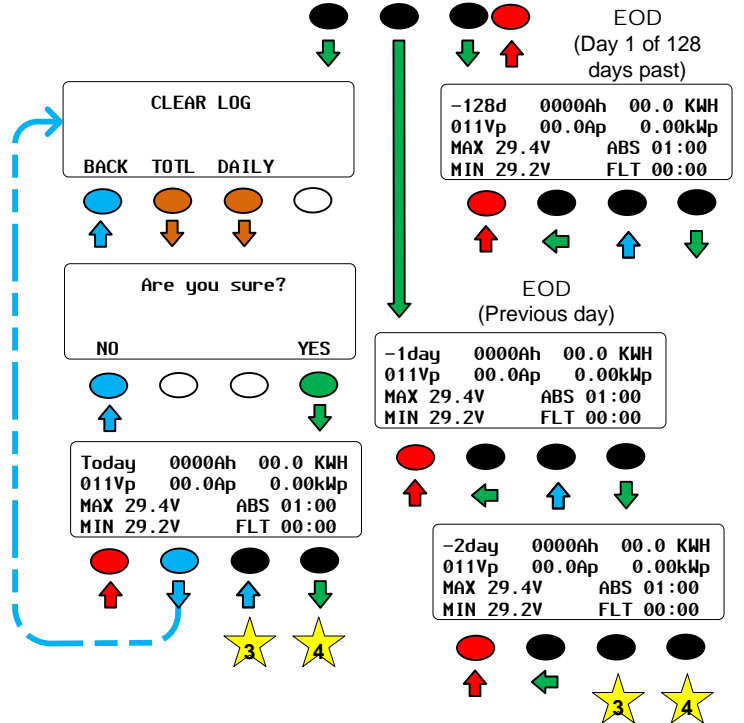
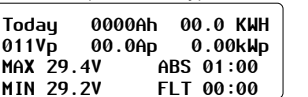

Continuing to press this soft key will cycle backwards by 1 day up to 128 days.
Press and hold this soft key to automatically scroll backwards through the available days.

Continuing to press this soft key will cycle forward by 1 day up to 128 days.
Press and hold this soft key to automatically scroll forward through the available days.