

BMV-712 Smart: Bluetooth inside

www.victronenergy.com



BMV-712 Smart



BMV bezel square



BMV shunt 500A/50mV
With quick connect pcb



See the **VictronConnect BMV app**
Discovery Sheet for more screenshots

Bluetooth inside

With Bluetooth built-in, the BMV Smart is ready for the Internet of Things (IoT) era. With Bluetooth being implemented in most other Victron Energy products, wireless communication between products will simplify system installation and enhance performance.

Download the Victron Bluetooth app

Use a smartphone or other Bluetooth enabled device to

- customize settings,
- monitor all important data on single screen,
- view historical data, and to
- update the software when new features become available.

Easy to install

All electrical connections are to the quick connect PCB on the current shunt. The shunt connects to the monitor with a standard RJ12 telephone cable. Included: RJ 12 cable (10 m) and battery cable with fuse (2 m); no other components needed.

Also included are a separate front bezel for a square or round display appearance, a securing ring for rear mounting and screws for front mounting.

Midpoint voltage monitoring

One bad cell or one bad battery can destroy a large, expensive battery bank. When batteries are connected in series, a timely warning can be generated by measuring the midpoint voltage. Please see the BMV manual, section 5.2, for more information.

We recommend our **Battery Balancer** (BMS012201000) to maximize service life of series-connected lead-acid batteries.

Very low current draw from the battery

Current consumption: 0,7Ah per month (1mA) @12V and 0,6Ah per month (0,8mA) @ 24V

Especially Li-ion batteries have virtually no capacity left when discharged until low voltage shutdown. After shutdown due to low cell voltage, the capacity reserve of a Li-ion battery is approximately 1Ah per 100Ah battery capacity. The battery will be damaged if the remaining capacity reserve is drawn from the battery. A residual current of 10mA for example may damage a 200Ah battery if the system is left in discharged state during more than 8 days.

Bi-stable alarm relay

Prevents increased current draw in case of an alarm.

Other features

- Battery voltage, current, power, ampere-hours consumed and state of charge
- Remaining time at the current rate of discharge
- Programmable visual and audible alarm
- Programmable relay, to turn off non critical loads or to run a generator when needed
- 500 Amp quick connect shunt and connection kit
- Shunt selection capability up to 10.000 Amps
- VE.Direct communication port
- Stores a wide range of historical events, which can be used to evaluate usage patterns and battery health
- Wide input voltage range: 6,5 – 70V
- High current measurement resolution: 10 mA (0,01A)
- Additional input to measure voltage (of a second battery), temperature or midpoint voltage, and corresponding alarm and relay settings

Battery Monitor	BMV-712 Smart
Supply voltage range	6,5 - 70 VDC
Current draw, back light off	< 1mA
Input voltage range, auxiliary battery	6,5 - 70 VDC
Battery capacity (Ah)	20 - 9999 Ah
Operating temperature range	-40 +50°C (-40 - 120°F)
Measures voltage of second battery, or temperature, or midpoint	Yes
Temperature measurement range	-20 +50°C
VE.Direct communication port	Yes
Bistable relay	60V / 1A normally open (function can be inverted)

RESOLUTION & ACCURACY (with a 500 A shunt)	
Current	± 0,01A
Voltage	± 0,01V
Amp hours	± 0,1 Ah
State of charge (0 – 100%)	± 0,1%
Time to go	± 1 min
Temperature (0 - 50°C or 30 - 120°F)	± 1°C/°F
Accuracy of current measurement	± 0,4%
Accuracy of voltage measurement	± 0,3%

INSTALLATION & DIMENSIONS	
Installation	Flush mount
Front	63mm diameter
Front bezel	69 x 69mm (2.7 x 2.7 inch)
Body diameter	52mm (2.0 inch)
Body depth	31mm (1.2 inch)

STANDARDS	
Safety	EN 60335-1
Emission / Immunity	EN 55014-1 / EN 55014-2
Automotive	ECE R10-4 / EN 50498

ACCESSORIES	
Shunt (included)	500A / 50mV
Cables (included)	10 meter 6 core UTP with RJ12 connectors, and cable with fuse for '+' connection
Temperature sensor	Optional (ASS000100000)



1000A/50mV, 2000A/50mV and 6000A/50mV shunt

The quick connect PCB on the standard 500A/50mV shunt can also be mounted on these shunts.



Interface cables

- VE.Direct cables to connect a BMV 712 to the Color Control (ASS030530xxx)
 - VE.Direct to USB interface (ASS030530000) to connect several BMV 70x to the Color Control or to a computer.

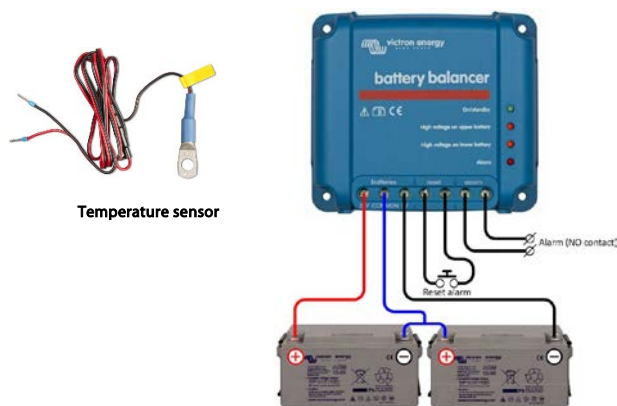

Temperature sensor

Battery Balancer (BMS012201000)

The Battery Balancer equalizes the state of charge of two series connected 12V batteries, or of several parallel strings of series connected batteries.

When the charge voltage of a 24V battery system increases to more than 27V, the Battery Balancer will turn on and compare the voltage over the two series connected batteries. The Battery Balancer will draw a current of up to 1A from the battery (or parallel connected batteries) with the highest voltage. The resulting charge current differential will ensure that all batteries will converge to the same state of charge.

If needed, several balancers can be paralleled.

A 48V battery bank can be balanced with three Battery Balancers.



Color Control

The powerful Linux computer, hidden behind the colour display and buttons, collects data from all Victron equipment and shows it on the display. Besides communicating with Victron equipment, the Color Control communicates through CAN bus (NMEA2000), Ethernet and USB. Data can be stored and analysed on the VRM Portal.

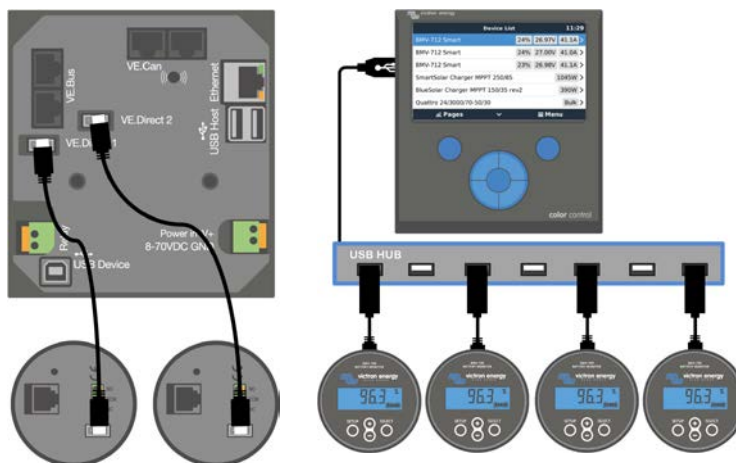

A maximum of four BMVs can be connected directly to the Color Control. Even more BMVs can be connected to a USB Hub for central monitoring.



Venus GX

The Venus GX provides intuitive control and monitoring. It has the same functionality as the Color Control GX, with a few extras:

- lower cost, mainly because it has no display or buttons
- 3 tank sender inputs
- 2 temperature inputs