



# User Manual

## E-BOX Series

LITHIUM ION BATTERIES



# Pytes E-BOX SERIES LFP Battery User Manual

## Dear customer,

This is your Pytes E-BOX SERIES LFP battery for home energy storage system. We provide safe, well-designed and high-performance standard LFP battery packs for you. The battery pack is compact, easy to install, free of maintenance and is used as the basic building block of an energy storage system by connecting in parallel. It is widely used in home applications, small commercial and industrial energy storage systems as well as Telecommunication stations.

This manual contains all the information necessary to install, use and maintain the LFP battery. We kindly ask you to read this manual carefully before using the product.

This manual is meant for the installers and the users of the LFP battery pack. Only qualified skilled person (electrician) may install and perform maintenance on the LFP battery pack.

The boundaries of its use, as described in this manual, should be kept in mind. This LFP battery pack may not be used in medical or in aviation related applications. This LFP battery pack may not be used for any purposes other than described in this manual. Using the LFP battery pack for any other purpose will be considered improper use and will void the warranty of the product. Pytes cannot be held responsible for any damage caused by improper or incorrect use of the product. Read and understand this manual completely before using the product. During the use of this product, user safety instructions should always be followed to ensure the safety of installers, users, service personnel and third parties.

This is the original manual, keep it in a safe location! Please consult <http://www.pytesusa.com> for the latest version of all manuals.

## Shanghai Pytes Energy CO., LTD.

Add: No.3492 Jinqian Road, Qingcun Town, Fengxian District, Shanghai, China.

Website: <http://www.pytesusa.com>

Email: [ess\\_support@pytesgroup.com](mailto:ess_support@pytesgroup.com)

# Before Using

Read and understand the following instructions:

## Warning

1. This equipment may only be installed, operated and maintained by qualified skilled person (electrician).
2. The local safety regulations and relevant operating procedures must be observed during the installation, operation and maintenance of the equipment, otherwise the equipment may get damaged. The safety precautions mentioned in the manual are only intended to supplement the local safety regulations.

## Caution

1. Do not dispose of batteries in fire. The batteries may explode.
2. Do not open or mutilate batteries. Released electrolyte can prove harmful to the skin and eyes. It may be toxic.
3. A battery can present a risk of electric shock and burns by high short-circuit current.
4. A malfunctioned battery can reach temperatures that exceed the threshold of contact surface.









The following precautions should be observed when working on batteries:

- a) Disconnect the power and consumer before connecting or disconnecting battery terminals;
- b) Do not wear any metal objects including watches and rings;
- c) Use tools with insulated handles;
- d) Do not lay tools or metal parts on top of batteries;
- e) Wear personal protective equipment.
- f) Ensure that if the battery is either intentionally or inadvertently grounded. Contacting with any part of a grounded battery can cause electric shock and burns by high short-circuit current. The risk of such hazards can be reduced if ground surroundings are removed during installation and maintenance by a skilled person.

## Danger

1. Keep the Li-ion battery away from water, dust and contamination, otherwise it may cause explosion or other harmful conditions that may even lead to personal injury.
2. Do not short-circuit the Li-ion battery.
3. Observe the plus (+) and minus (-) marks on the Li-ion battery and equipment and ensure correct use. Do not reverse connect the Li-ion battery.
4. Do not dismantle, crush, puncture, open or shred the Li-ion battery.
5. Before removing or reconnecting with the running system, the power must be off and the system should be shut down, otherwise there will be risk of electric shock.
6. Do not expose Li-ion battery to heat or fire. In case of fire, please use dry powder fire extinguisher.
7. Do not dismantle any part of the system without contacting PYTES or PYTES authorized technical engineers. System failure caused by such will not be covered by the warranty.
8. Before operating inverter, make sure that all batteries have been started up.

# Symbols

	Read the instruction manual before starting installation and operation.
	caution, do not dispose of batteries in a fire, the battery may explode.
	caution, a battery can present a risk of electric shock and burns by high short-circuit current. do not short-circuit the Li-ion battery.
	caution, do not dispose the product with household wastes.
	danger, keep the Li-ion battery away from water, dust and contamination, otherwise it may cause explosion or lead to personal injury.
	danger, do not place near open flame or flammable materials.
	danger, do not place at children or pet touchable area.
	Recyclable.

# CONTENTS





<b>1 Specifications</b>	5
1.1 Product standard configuration	6
1.2 BMS function	6
<b>2 Interface and protection functions</b>	7
2.1 Battery front panel schematic	7
2.2 Components	7
<b>3 Operating Environment</b>	8
<b>4 Packaging, transportation, storage requirements</b>	8
4.1 Transportation	8
4.2 Storage	8
<b>5 Installation and configuration</b>	8
5.1 Installation preparation	8
5.2 Unpacking	9
5.3 The preparatory work	9
5.4 Installation	10
<b>6 Communication</b>	12
6.1 RS232 port	13
6.2 RS485 port and CAN port.	13
<b>7 Troubleshooting</b>	13
7.1 Unable to start	13
7.2 Unable to charge	14
7.3 Unable to discharge	14
7.4 ALM constantly on	14

# 1 Specifications

Table 1-1 Battery Pack Specifications

Battery Model	E-BOX-4850	E-BOX-48100R
Chemistry	LFP	LFP
Nominal Voltage	48V	51.2V
Voltage Range	45V-54V	47.5V-57.6V
Nominal Capacity	50Ah	100Ah
Nominal Energy	2.4kWh	5.12kWh
Unit Dimension	L440mm*W420mm*H89mm(2U)	L440mm*W620mm*H117mm(2.6U)
Unit Weight	25kg	51kg
Standard Charge/ Discharge Current	25A	50A
Maximum Charge/ Discharge Current	50A	100A
Peak Current	102A@15s	102A@15s
Round-Trip Efficiency	≥95%	≥95%
Communication Protocol	RS232, RS485, CAN	RS232, RS485, CAN
Cycle Life	≥6000cycles@0.5C/0.5C@ 25°C	≥6000cycles@0.5C/0.5C, 25°C
Calendar Life	≥10years	≥10years
Operating Temperature	Charge: 0°C~ 45°C, Discharge: -10°C~ 50°C	Charge: 0°C~ 45°C, Discharge: -10°C~ 50°C
Certificates	IEC62619 / UN38.3	UL1973, IEC62619 / UN38.3/UL9540A/UL9540
Storage Temperature	Within 1month: -20~45°C 1-3months: -20~35°C 3-12months: 20~25°C	Within 1month: -20~45°C 1-3months: -20~35°C 3-12months: 20~25°C

## 1.1 Product standard configuration

Items	Quantity	Specifications	Pictures
E-BOX SERIES	1pc	LFP pack; including BMS,three interfaces (CAN/RS-485/RS232), 2 Link ports, LED power indicator and insulated coating metal case.	 <p>(For reference only)</p>
Communicate Cable	1pc	Connect battery to battery; 0.2m; CAN or RS485 communicate	
Earthing cable	1pc	1m	
Mounting Brackets	4pcs	Fix the battery on the wall with expansion screws	

## 1.2 BMS function

Protection and Alarm	Management and Monitor
Charge/Discharge End	Cell Balance
Charging over Voltage	Intelligent Charge Model
Charge/Discharge Over Current	Charge/Discharge current Limit
High/Low Temperature	Capacity Retention Calculation
Short Circuit	Administrator Monitor
Power Cable Reverse	Record

# 2 Interface and protection functions

## 2.1 Battery front panel schematic

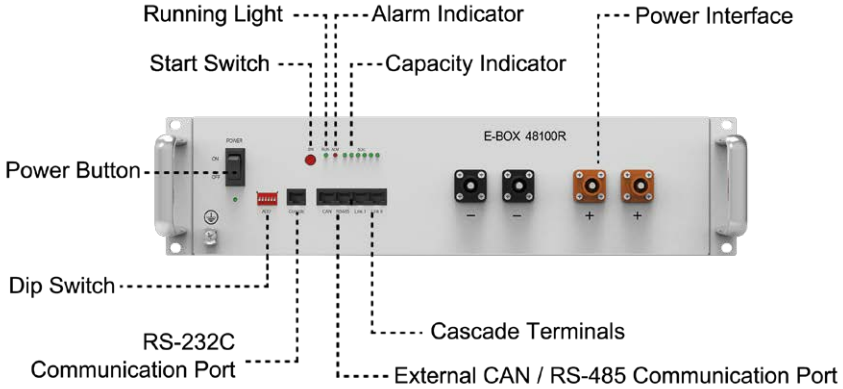

## 2.2 Components

No.	Name	Label	Functions description
1	Ground	⊕	Grounding
2	Power button	POWER	When switched to "ON", the system can be activated by the "SW" key or external power supply; when switched to "OFF", the system is off.
3	Start Switch	SW	Press and hold this button for 1 second while the switch key is "ON" to enter Start or Sleep mode
4	DIP Switch	ADD	Select the matching manufacturer, see the match list (appendix C)
5	Running Light	RUN	Green light. The light flashes when Standby. The light is constantly on when charging. The light flashes when discharging.
	Alarm Indicator	ALM	Red light. The light flashes when Alarming. The light is continuously on when protected.
	Capacity Indicator	SOC	A total of 6 green lights showing battery capacity, each representing 16.7% of SOC.
6	External CAN Communication Port	CAN	Communication with external devices
7	External RS-485 Communication Port	RS485	Communication with external devices
8	Cascade Terminals	Link 1/0	The master is connected to PORT1, and the slave is connected to PORT0.
9	Power interface (negative)	"-"	Negative input and output interface
10	Power interface (positive)	"+"	Positive input and output interface

**Warning:** 6,7,8,9,10 is DVC-A circuit, they shall not be connected to DVC-B/C circuit when installed, or hazard shock will occur.



## 3 Operating Environment

- ◇ Battery operating environment requirements:
- ◇ Operating Temperature: -10°C~50°C
- ◇ Relative Humidity: 20%-80%, no condensation
- ◇ Altitude: <4000m
- ◇ Site environment requirements: Keep away from heat source, avoid direct sunlight, no corrosive gas, no explosive gas, no insulating gas, no insulating conductive dust.
- ◇ Installed in cabinet which shall not be opened without a tool or
- ◇ install in a restricted access area.

## 4 Packaging, transportation, storage requirements

### 4.1 Transportation

Always check all applicable local, national, and international regulations before transporting an LFP battery.

During the transportation, protect the battery from severe vibration, shock or squeeze, and from exposure to the sunlight and rain.

During the loading and unloading process, the battery should be handled lightly and should be protected against falling, rolling and from being pressed with heavy pressure.

### 4.2 Storage

Follow the storage instructions in this manual to optimize the lifespan of the LFP battery during storage. If these instructions are not followed and the LFP battery has no charge remaining when it is checked, consider it to be damaged. Do not attempt to recharge or use it. Replace it with a new LFP battery.

See previous storage temperature conditions.

Keep the battery SOC to 40%-60% during storage. The Self-discharge of the LFP battery pack is 1-2% per month.

Disconnect the LFP battery from all loads and, if present, the charging device.

Store the battery in a cool and dry place without direct sunlight.

Keep the battery pack away from corrosive substances, inflammable and explosive material as well as hazardous gases.

Charge the LFP battery to more than 80% of its rated capacity for long-term storage(>6months). The battery needs to be recharged every 6 months to more than 80% of the rated capacity.

## 5 Installation and configuration

### 5.1 Installation preparation

#### 5.1.1 Safety Requirements

Only those who have been trained in the power system and have a good knowledge of the power system are allowed to install the device. Always observe local safety regulations and the safety requirements listed below during the installation process.

Before installing or removing the battery, make sure that the system is cut off from any power source

and that the battery device is turned off. Distribution cabling needs to be handled carefully with reasonable protective measures to avoid being touched during the maintenance and operation.

### 5.1.2 Checking the operating environment

The operating environment should meet the requirements described in Chapter 3, "Operating Environment". Otherwise, it needs to be adjusted and re-examined.

### 5.1.3 Tools

The tools that may be used are shown in Table 5-1.

Table 5-1 Tools

Tools	
Screwdriver (Slotted, Phillips)	Multimeter
Wrench	Clip-on ammeter
Diagonal pliers	Insulating tape
Thermometer	Pliers
Anti-static wrist ring	Clip Pliers
Tapes	Strippers

### 5.1.4 Technical preparation

Electrical interface settings:

If the battery is connected to the user device directly, please check:

- ◇ Whether the DC charging interface of the energy storage inverter meets the charging voltage and current requirements in Table 1-1 Battery Pack Specifications.
- ◇ Whether the power of the electrical equipment matches the parameters listed in "Table 1-1 Battery Pack Specifications";

Security check:

Fire-fighting equipment such as portable dry powder fire extinguishers should be available near the equipment. Do not place dangerous materials such as any flammable or explosive ones near the battery.

## 5.2 Unpacking

- ◇ When the battery arrives at the installation site, it must be unloaded and stored properly and prevented from the direct sunshine and rain. Before installation, check if there is any component missing according to 1.1 product standard configuration and check whether the box appearance is intact;
- ◇ Carefully handling the unpacking. Protect the insulated coating on the case surface;
- ◇ Check the LFP battery for damage after unpacking. If there is any damage, contact Pytes or your reseller.

## 5.3 The preparatory work

1. Make sure the POWER buttons of all batteries are OFF.
2. Ensure the charging voltage of power supply equipment is  $DC57.5 \pm 0.1V$ ;

3.All power supply should be off.

## 5.4 Installation

### 5.4.1 Install the battery

The E-BOX SERIES can be installed either vertically or horizontally. In this chapter, instructions here are only for horizontal installation such as: installation in a 19-inch cabinet. Vertical installation is similar. All equipment must be placed steadily after installation.

### 5.4.2 Connect Ground cable

Unscrew the screw at the grounding hole on the front panel of the battery, wrap the ground cable around the screw, and tighten it with a screwdriver. Connect the other end of the ground cable to a reliable ground point.

 Note: The grounding resistance should be less than 0.1Ω.

### 5.4.3 Connecting the power cable

Before connecting the power cable, connect and disconnect the cable to identify the positive and negative terminal, then make a mark respectively. After the cable is connected, measure whether there is a short-circuit or reverse connection.

AWG	Area		Standard Current	Max. Current
	(kcmil)	(mm <sup>2</sup> )	(A)	(A)
4	41.7	21.15	83.5	95.2
5	33.1	16.77	66.2	75.5
6	26.3	13.3	52.5	59.9
7	20.8	10.55	41.6	47.5
8	16.5	8.37	33	37.7
9	13.1	6.63	26.2	29.8
10	10.4	5.26	20.8	23.7

It should be > 6 AWG.

Connecting the power cables:

1)Power cable connection instructions of Single-Rack:Select the correct line based on your load by referencing to the table below:

#### ◇ Single battery:

Connect the positive and negative poles of the battery to the positive and negative terminal of the DC port of the energy storage inverter (or the junction box) with a red and black cable respectively.

#### ◇ Multiple batteries (Max number 8):

The connection of several batteries is only permitted in parallel. Firstly, connect the positive poles with the red cables, and connect the negative poles with the black cables. Next connect the positive and negative poles of the battery to the positive and negative poles of the DC port of the hybrid inverter (a storage device or a junction box) with a red and black cable.

The standard charge/discharge current of each single battery is the same no matter how many batteries are paralleled refer to the "Table1-1". Bus bar should be applied when higher current (>100A) is needed for specific projects.

The capacity can be increased by connecting the batteries in parallel, but due to the limitations of BMS and power cable, Max. 8 batteries can be connected in parallel as a group without any additional kits and a bus bar should be used for connecting them together.

 Warning: Batteries connected in series are forbidden, high voltage would lead to hazard shock.

## 2) Power cable connection instructions of multi-Rack:

Collect the positive and negative power cables respectively by the bus bar or junction box, then connect two racks in parallel.

The length, thickness, material, and resistance of the cables connected in parallel must be the same.

**⚠ Note:** When the cable is inserted into the positive and negative terminals of the battery and you hear a “Click” sound, the cable is firmly connected. Before pulling out the cable, press the small button next to the terminal. When multiple batteries are connected in parallel, in order to reduce the influence of the circular current, the overall positive and negative output cables can be connected from different batteries to a Bus-Bar.

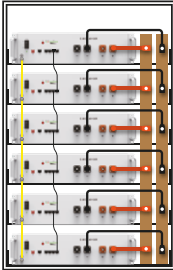
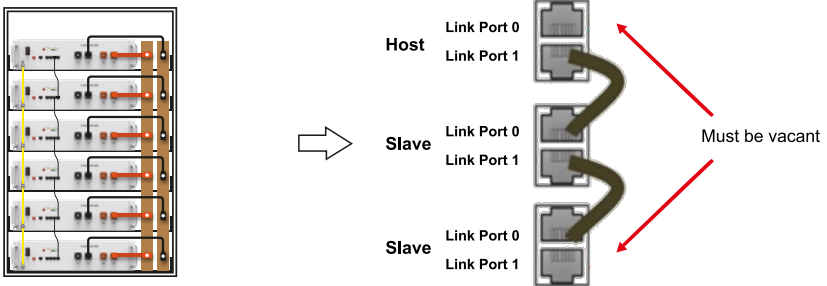

Figure 5-1 Schematic diagram of battery connection

**⚠ Note:** The battery must be placed in a locked cabinet or room, and a 5cm cooling gap is reserved when installing the battery, and the battery cabinet should have a load capacity of more than 100kg

### 5.4.4 Connecting communication cables

Single battery: Choose port to be inserted according to the communication protocol (RS485/-CAN/RS232) between the battery and ESS inverter, then insert the communication cables to the port;



Multiple batteries: The host and the slave communicate in cascade mode: one is the host and the rest are the slaves. Please refer to the following picture for the cascade connection. User needs to insert communication cables to relevant link ports between batteries and be aware that:

- 1.The host Link Port 0 must be kept free;
- 2.The end slave Link Port 1 must be kept free;

**⚠ Note:** The system may not be able to communicate if not followed the instruction.

### 5.4.5 Procedure of starting/Shut down the whole system

How to start and shut down the whole system correctly

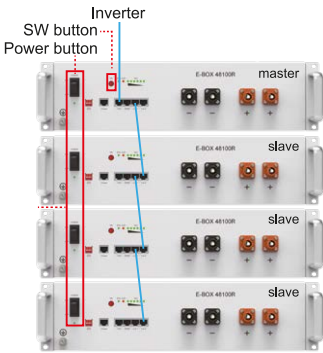

**Starting Procedure**

Step 1. Switch on all power button.

Step 2. Only press SW button of master battery for 1 second

\*Make sure that all batteries have been started, then running the inverter. To avoid battery shock by the in-rush current of the large capacitors of the inverter.

**Shut down Procedure**

Step 1. Only press SW button of master battery for 3 seconds

Step 2. Turn off all power button.

\*Wait for all the battery lights to go out before turning off the power button.

Table 5-2 LED indications

Battery status	Protection / Alarm / Normal	RUN	ALM	Capacity LED						Descriptions	
		●	●	●	●	●	●	●	●		
Shut down		OFF	OFF	OFF	OFF	OFF	OFF	OFF	OFF	OFF	All off
Power-on	Normal	ON	ON	ON	ON	ON	ON	ON	ON	ON	All light on one second at same time.
Standby	Normal	Blink 1	OFF	OFF	OFF	OFF	OFF	OFF	OFF	OFF	Indication standby
	Alarm	OFF	Blink 3	OFF	OFF	OFF	OFF	OFF	OFF	OFF	Battery low voltage
Charging	Normal	Light	OFF	Base on capacity							
	Alarm	Light	Blink 3	Base on capacity							
	Protection	OFF	Light	OFF	OFF	OFF	OFF	OFF	OFF	OFF	Stop charging, protect start
Discharge	Normal	Blink 3	OFF	Base on capacity							
	Alarm	Blink 3	Blink 3	Base on capacity							
	Protection	OFF	Light	OFF	OFF	OFF	OFF	OFF	OFF	OFF	Stop discharge, protect start

**⚠ Note:** The blinking descriptions: Blink 1 "0.3s on/3.7s off"; Blink 2 "0.5s on /0.5s off"; Blink 3 "0.5s on / 1.5s off"; Blink 4 "0.7s on / 9.3s off"

**---End of installation---**

## 6 Communication

There are RS-232C, RS485 and CAN communication ports on the battery. The battery status can be obtained and the battery internal parameters can be modified via a host computer.

### CAN

CAN communication Terminal (RJ45 port) follow CAN protocol, to output batteries information.

### RS485

RS485 Communication Terminal:(RJ45 port) follow RS485 protocol, to output batteries information.

### RS232

RS232 Communication Terminal:(RJ45 port) follow RS232 protocol, to upgrade the software and communicate with your PC.

### Link Port 0,1

Link Port 0,1 Communication Terminal:(RJ45 port) follow CAN/RS485 protocol, to communicate between multiple parallel batteries.

## 6.1 RS232 port

Table 6-1 RS232 Connector Pin Assignments

### Default baud rate of RS-232C ports:

Pin number	RS-232C port
1	
2	
3	RXD
4	GND
5	
6	TXD
7	
8	

## 6.2 RS485 port and CAN port.

Default baud rate of RS-485 port: 9600bps

Default baud rate of CAN port: 500K

Table 6-2 RS485 and CAN Connector Pin Assignments

Pin number	Serial	CAN
1	RS485B	
2	RS485A	
3	GND	
4		CANH
5		CANL
6	GND	
7	RS485A	
8	RS485B	

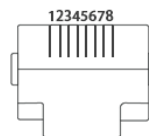

## 7 Troubleshooting

Please refer to the troubleshooting methods mentioned below. Please read the “Table 5 -2 LED indication” of this manual before troubleshooting to prevent false operations. For example, it doesn't indicate the battery is faulty if the ALM alarm red light on the front panel is blinking or constantly on. When there is an "alarm" indication, it usually works well and needs no troubleshooting. When there is "protection" indication, the battery will work normally automatically after “protection” status is released.

**⚠ Warning:** Do not repair the battery if no authorization from Pytes!

### 7.1 Unable to start

Problem	Troubleshooting Steps	Solution
Press the POWER button to the "ON" state and press the SW button for 1 second, but the LED indicator doesn't respond or all the LEDs are off after 1S.	<ol style="list-style-type: none"> <li>1. Confirm that the POWER button remains in the "ON" state;</li> <li>2. Charge the battery correctly and observe if the battery can be charged properly.</li> </ol>	<ol style="list-style-type: none"> <li>1. If the battery enters charging mode, the battery can return to normal after charging.</li> <li>2. If not, please contact the local reseller or Pytes.</li> </ol>

## 7.2 Unable to charge

Problem	Troubleshooting Steps	Solution
The unfully charged battery cannot be charged properly.	<ol style="list-style-type: none"><li>1. Confirm that the battery is turned on;</li><li>2. Check the power cable. Confirm that the power cables are correctly connected and the charging circuit is correct;</li><li>3. Check the battery indicator LED to see if the battery is under "Protection" state. If so, unplug the battery power cable, find the cause of the protection, and fix the problem, then restart the battery;</li><li>4. Check if the charging voltage meets the battery charging requirements. If not, adjust the power supply voltage to the proper range.</li></ol>	If the battery still does not charge properly after following the steps, please contact the local reseller or Pytes.

## 7.3 Unable to discharge

Problem	Troubleshooting Steps	Solution
The battery cannot be discharged properly.	<ol style="list-style-type: none"><li>1. Confirm that the battery is turned on;</li><li>2. Check the power cables to ensure that they are properly connected.</li><li>3. Unplug the battery power cable and measure the battery power output voltage. If the battery voltage is too low, charge it immediately.</li><li>4. Check the battery indicator LED to see if the battery is under "Protection" state. If so, unplug the battery power cables, find the cause of the protection, and fix the problem, then restart the battery;</li></ol>	If the battery still does not discharge properly after following the above steps, please contact the local reseller or Pytes.

## 7.4 ALM indicator(alarm) constantly on

When the ALM indicator is constantly red and the other indicators are off, the battery is in the "Protection" state. When the condition triggered protection is released, the battery will automatically return to normal operation. There are a few issues requiring immediate measures.

Problem	Troubleshooting Steps	Solution
The ALM indicator is constantly red and all other indicators are off.	<ol style="list-style-type: none"><li>1. Check the power cables to ensure that they are properly connected.</li><li>2. Check whether the charging voltage, charging/discharging current, battery/cell voltage and temperature meet the relevant protection conditions, and release the "protection" state to ensure that the voltage, current and temperature are within the normal working range.</li></ol>	If the battery protection state cannot be released, or the ALM indicator is constantly on when the battery is properly charged after it is restarted, please contact your local reseller or Pytes.

# Warranty Card

Customer information			
Contact name			
Phone number		Email	
Address			
Production information			
Battery model		Inverter brand/model	
Battery quantity		Inverter quantity	
Purchase date		Inverter using time	
Serial number		on-grid/off-grid	
Installer information			
Installer name		Installing date	
Problem description			
Photos of battery wiring			
Photos of inverter wiring and panels			





**Shanghai PYTES Energy Co., LTD**

Add: No.3492 Jinqian Road, Fengxian District, Shanghai, China

Tel: 021-57474761

Email: [ess\\_support@pytesgroup.com](mailto:ess_support@pytesgroup.com)